

1

Screw Fracture

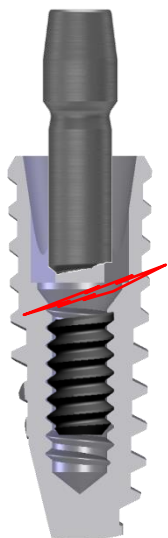

2

Damaged Internal thread

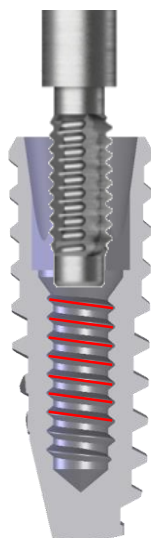

3

Abutment Fracture

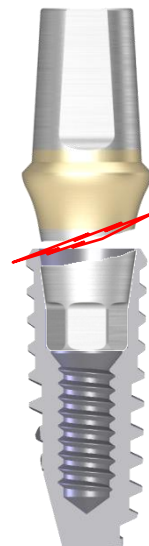

4

Screw Hex Slip

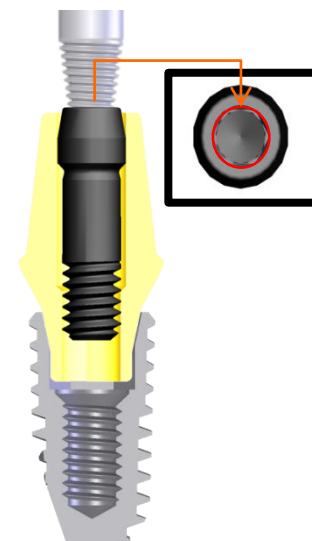

ESR KIT Components

1

Screw Fracture : Guide, ESR Handle, SR Drill, SR Tip, Screw Holder, Torque Driver Handle



ESR Handle



Guide



SR Drill



SR Tip



Screw Holder



Torque Driver Handle



ESR KIT Components

Screw Fracture

1. Guide

-A tool to avoid shaking and keep the center fixed when using components such as SR Drill.

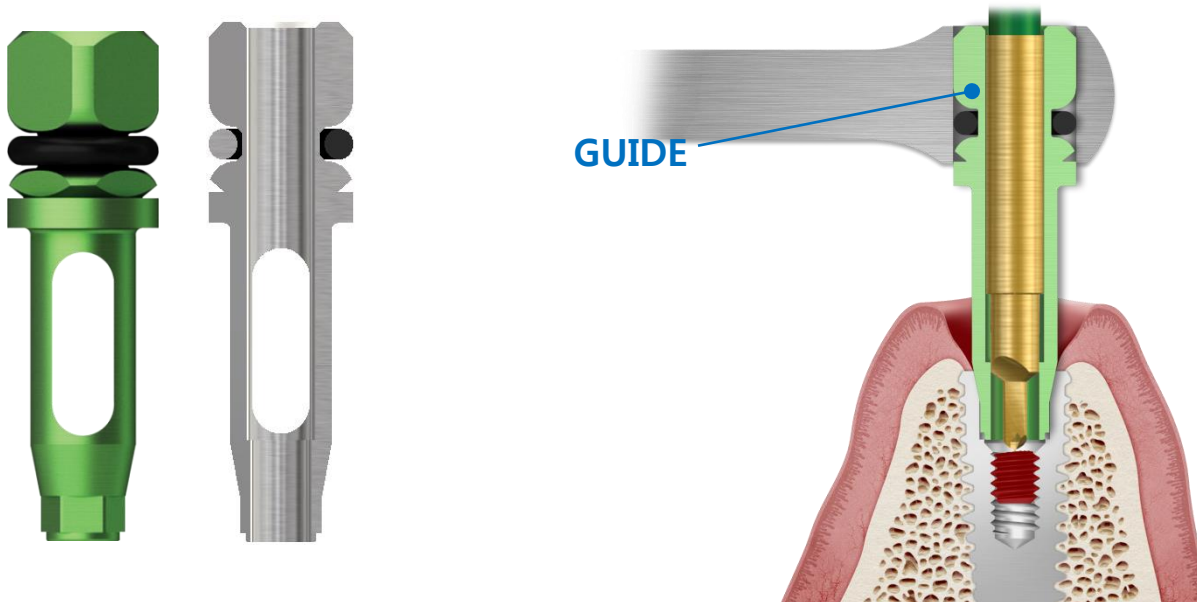

ESR KIT Components

Screw Fracture

2. ESR Handle

- A tool to strongly fix the guide

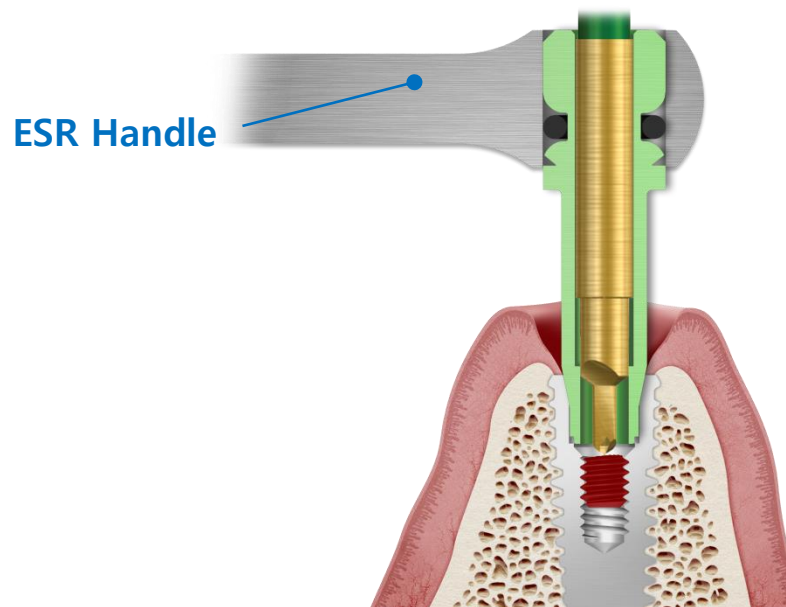

ESR KIT Components

Screw Fracture

3. Screw Removal Drill(SR Drill)

- To remove fractured screw inside the fixture by turning counter-clockwise
- Engine Setting : Counter-clockwise 1500rpm
- Recommended usage : 5 Times



Mini



Regular

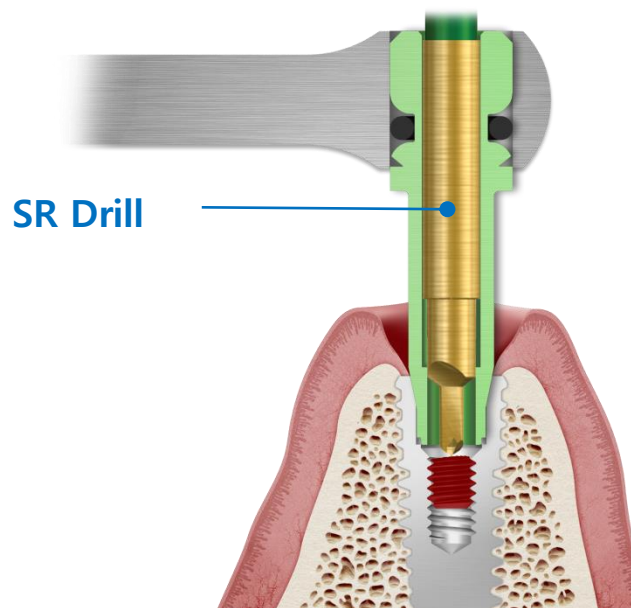

ESR KIT Components





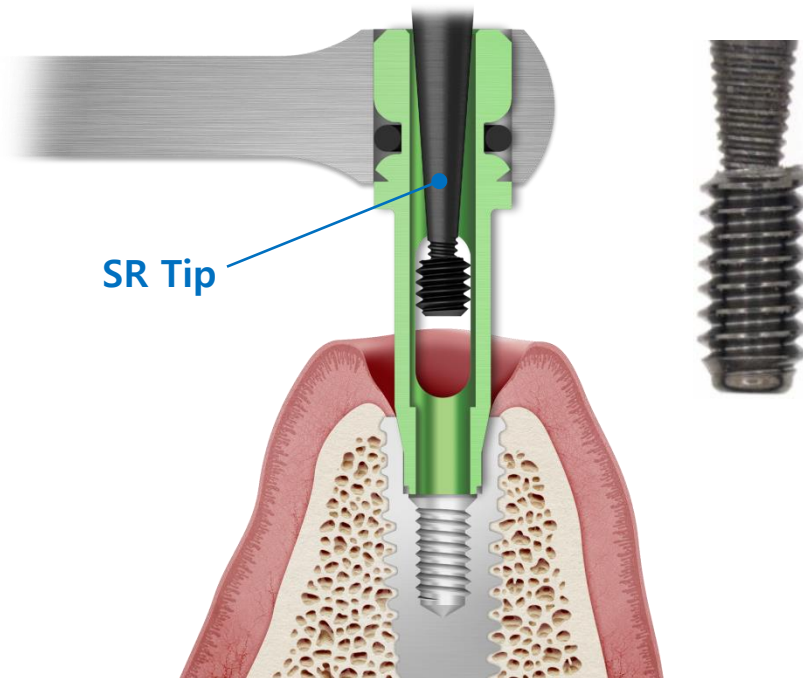

Screw Fracture

4. Screw Removal Tip(SR Tip)

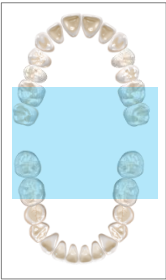
- To remove fractured screw by turning after connecting SR Tip to formed hole of the screw
- Used with Torque Driver Handle

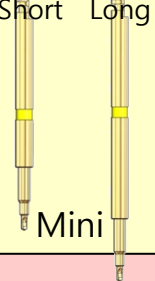

ESR KIT Selection Guide

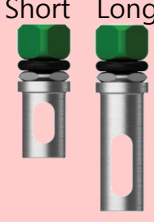
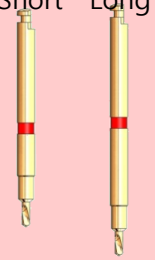
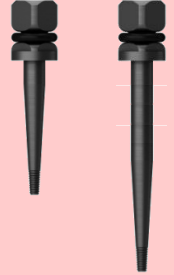
① Intermaxillary Space		② Tool selection						
		GUIDE			SR Drill		SR Tip	
		TS/GS	SS	US				
Short		Short Long 	Short Long 		Short Long 	Mini	Short Long 	Mini
	Long		Short Long 	Short Long 	Short Long 	Short Long 	Regular	Short Long 

ESR KIT Components

Screw Fracture

5. Screw Holder

- When the fractured screw partially protruded,
- Counter-clockwise

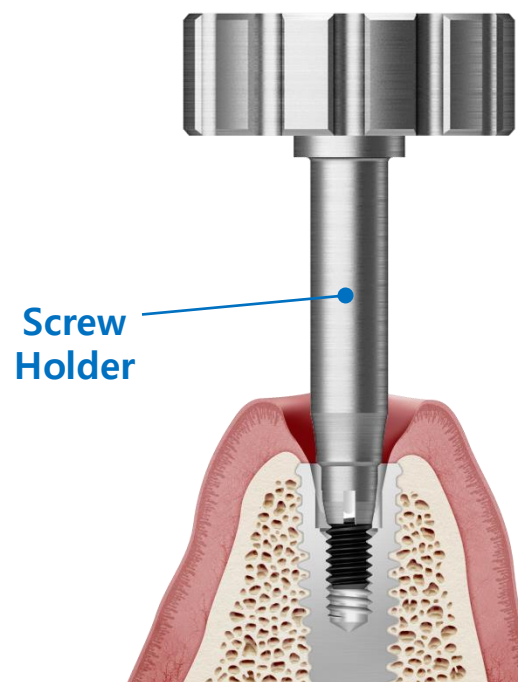

ESR KIT Components

Screw Fracture

6. Torque Driver Handle

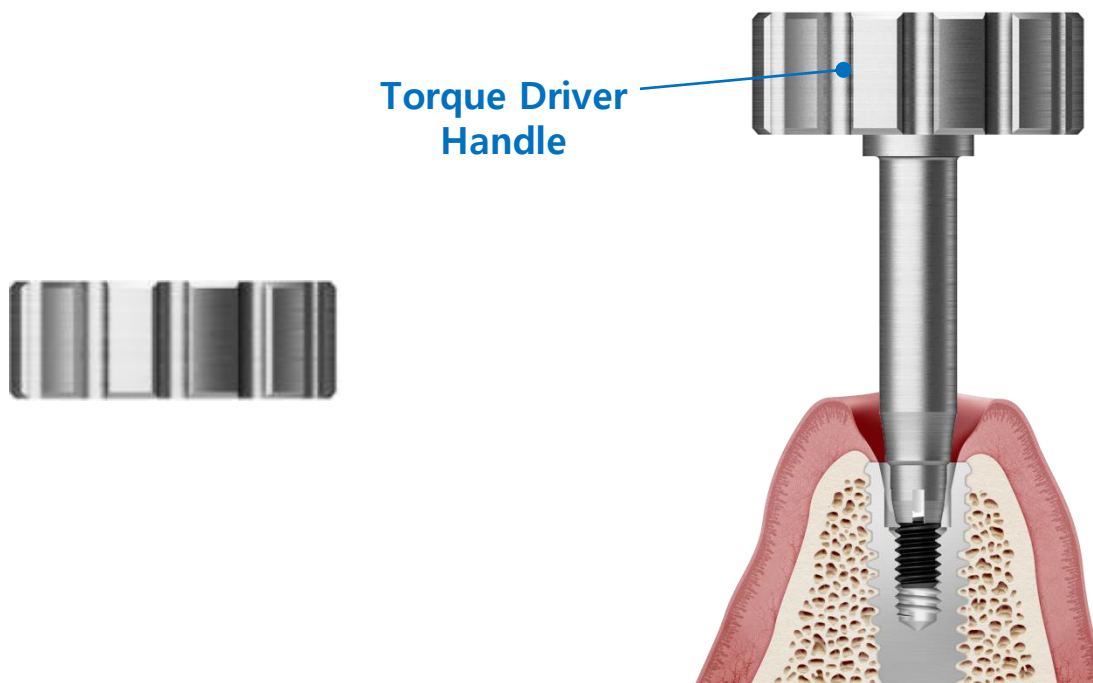



1. Fractured screw removal using “SR drill” and “SR Tip”

Fractured Screw

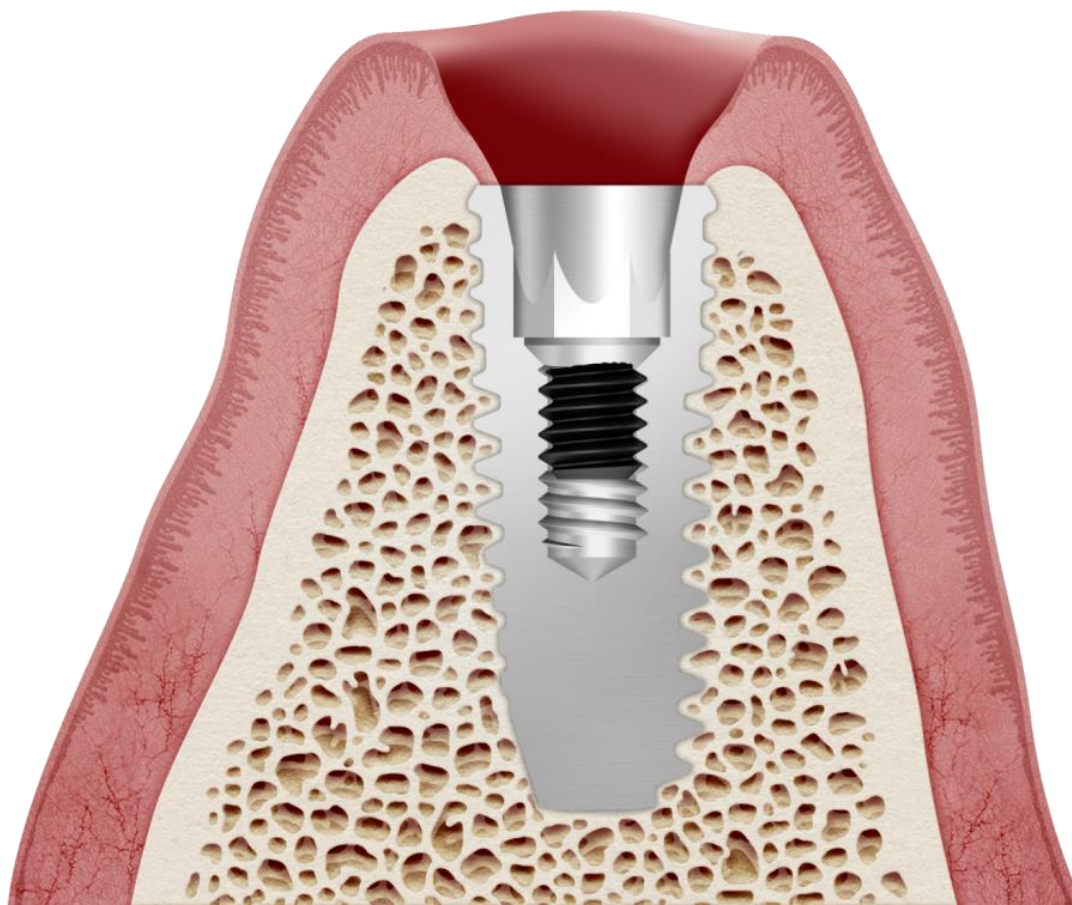

Fractured Screw

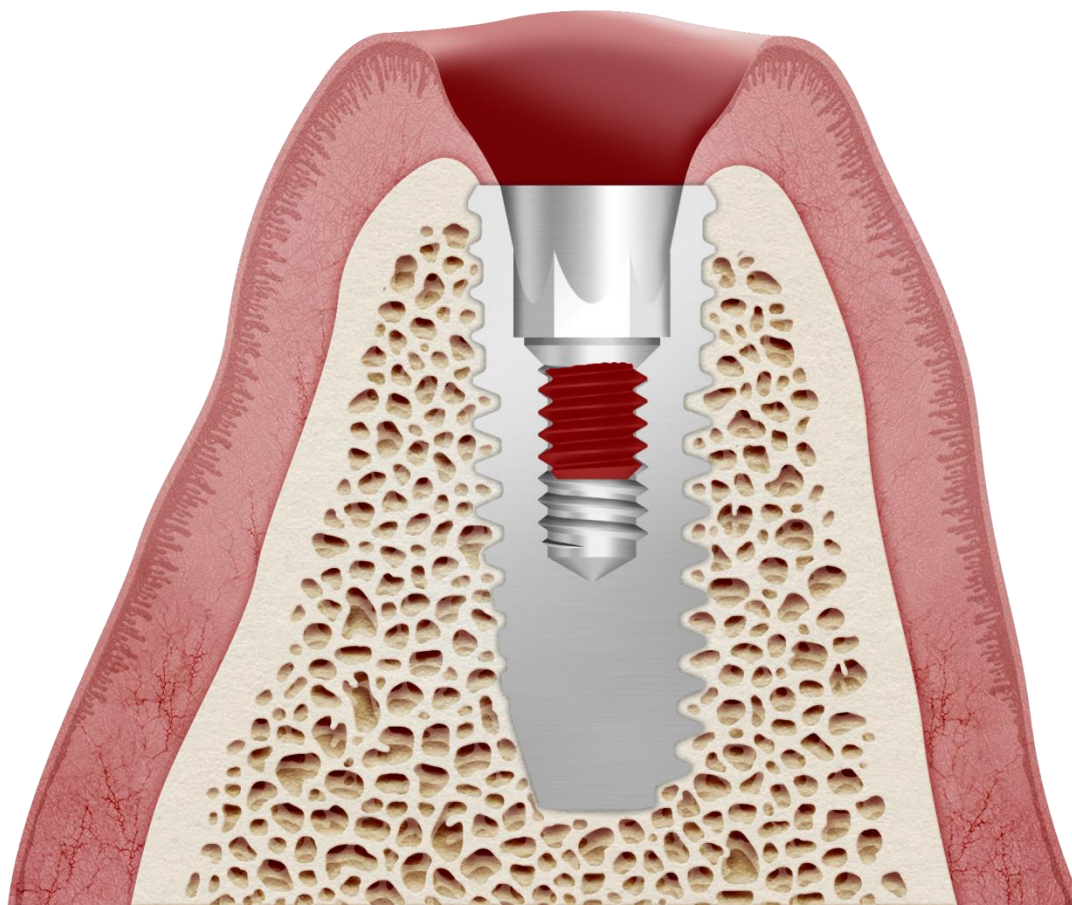

Connecting "Guide" to Fixture

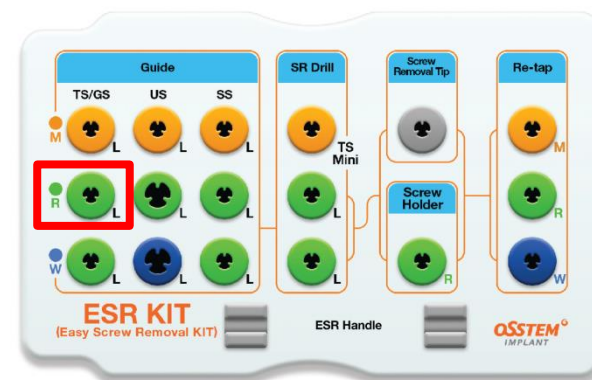
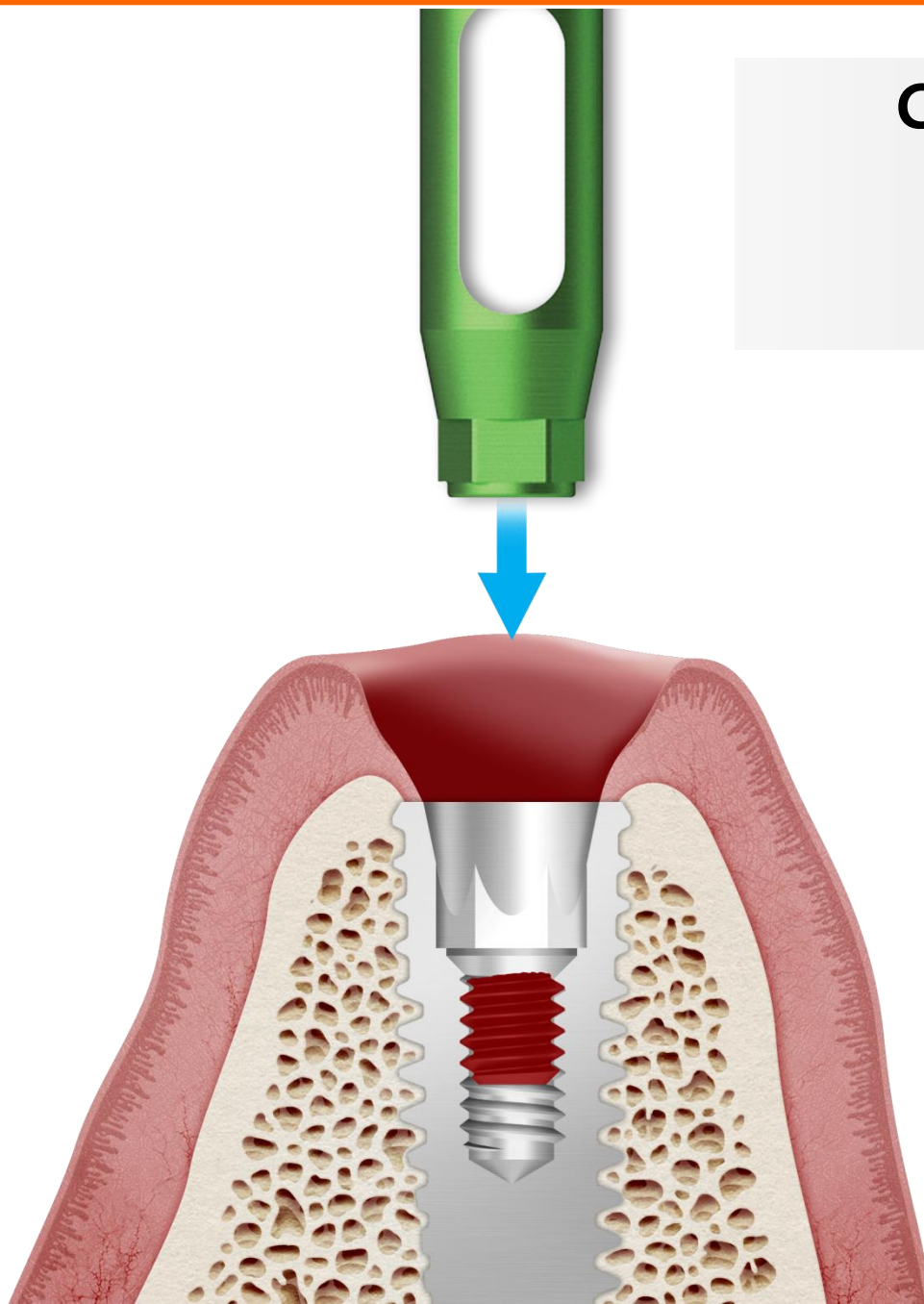

Connecting "Guide" to Fixture

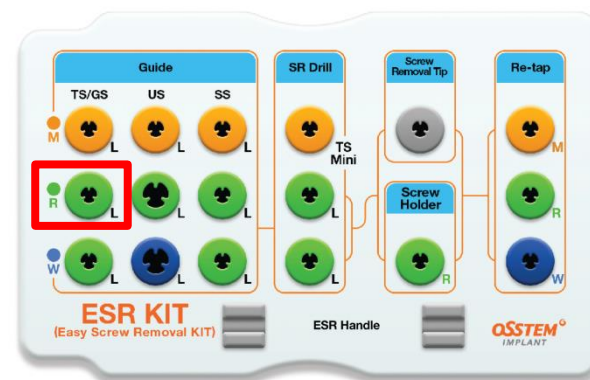
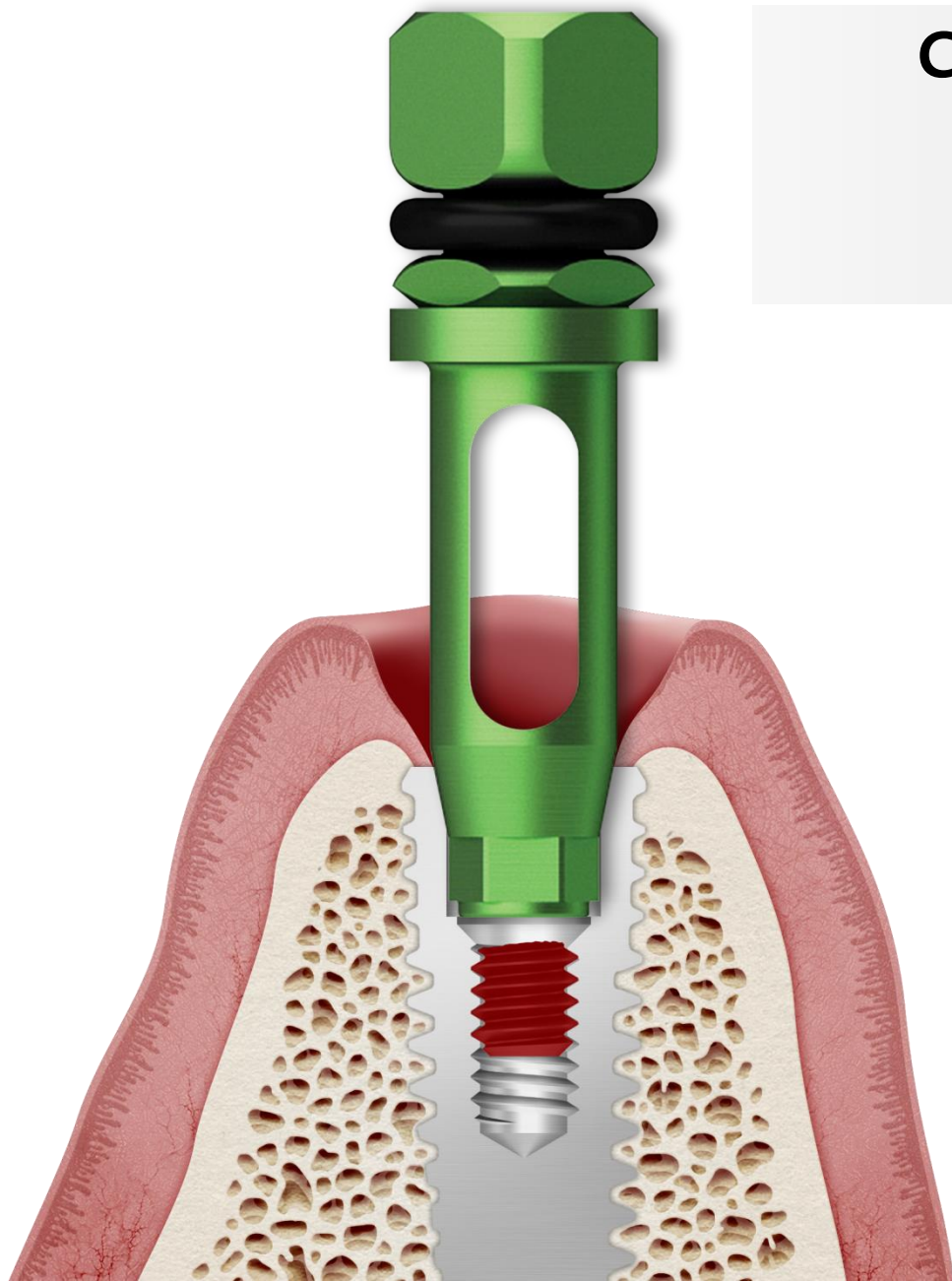

Connecting "ESR Handle" to "Guide"

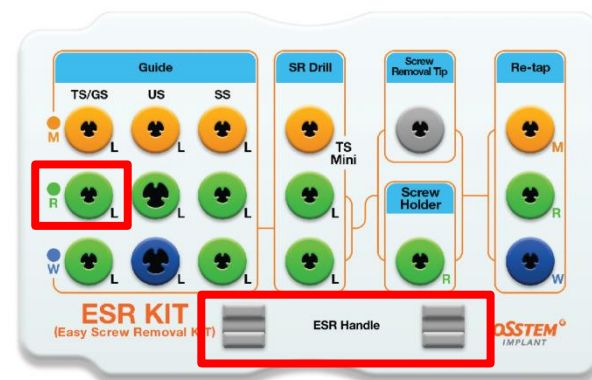
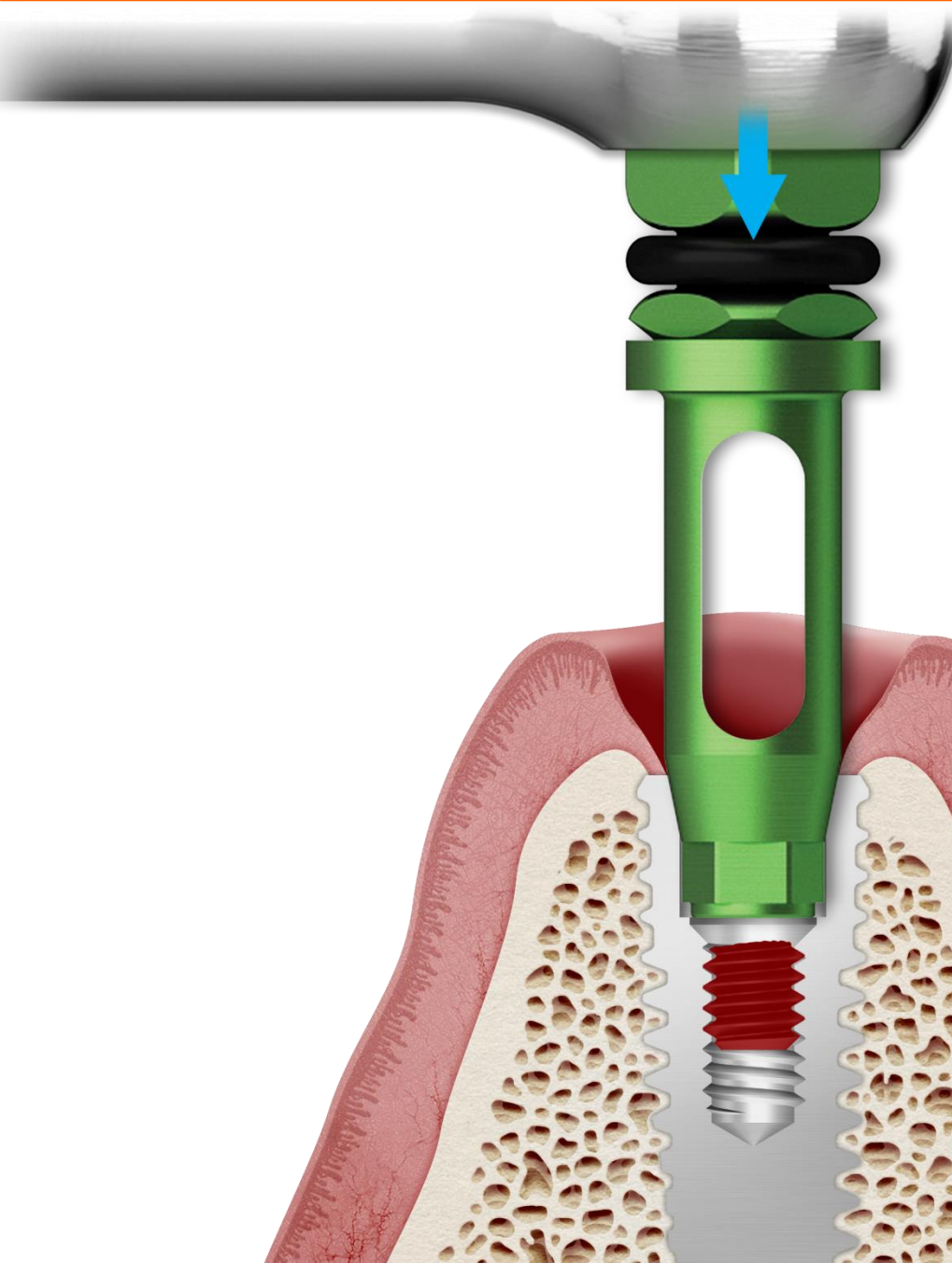

Connecting "ESR Handle" to "Guide"

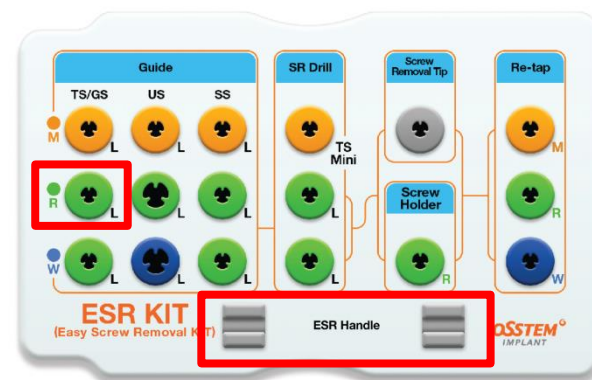
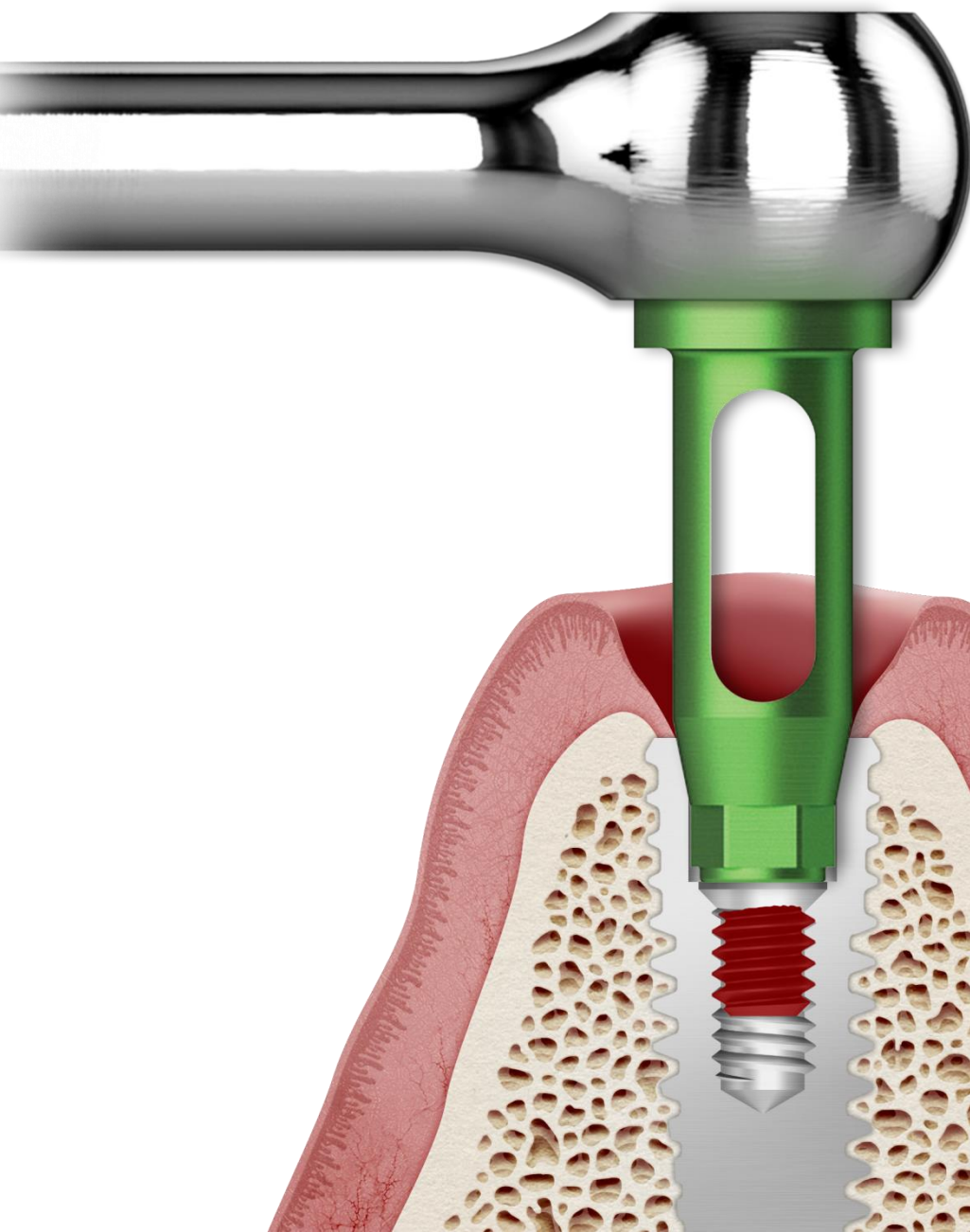

Connecting "ESR Handle" to "Guide"

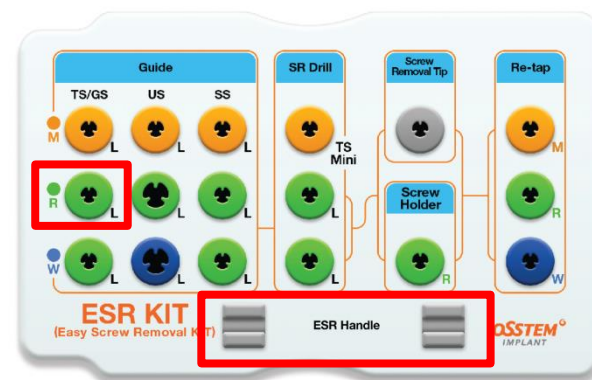
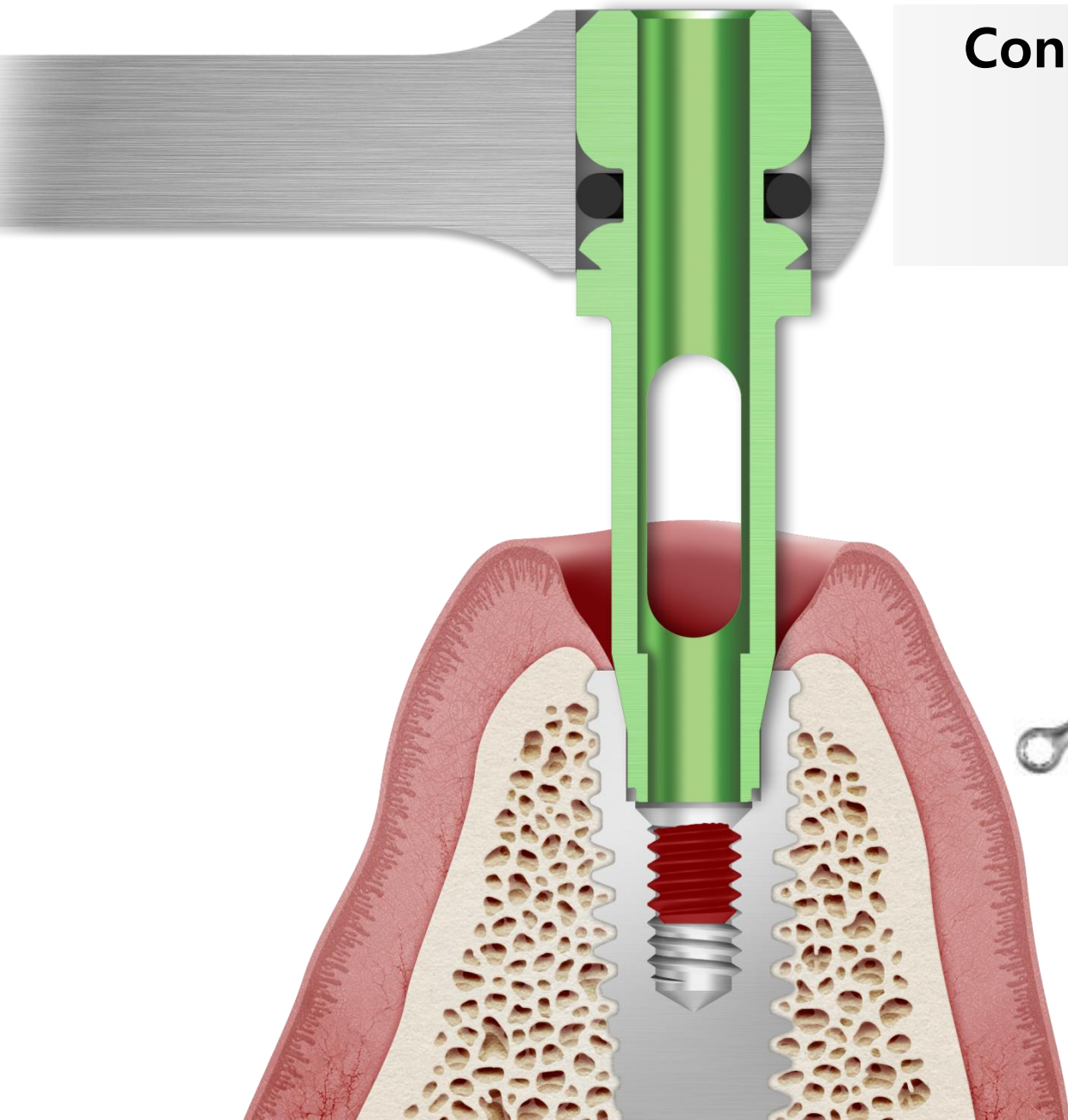

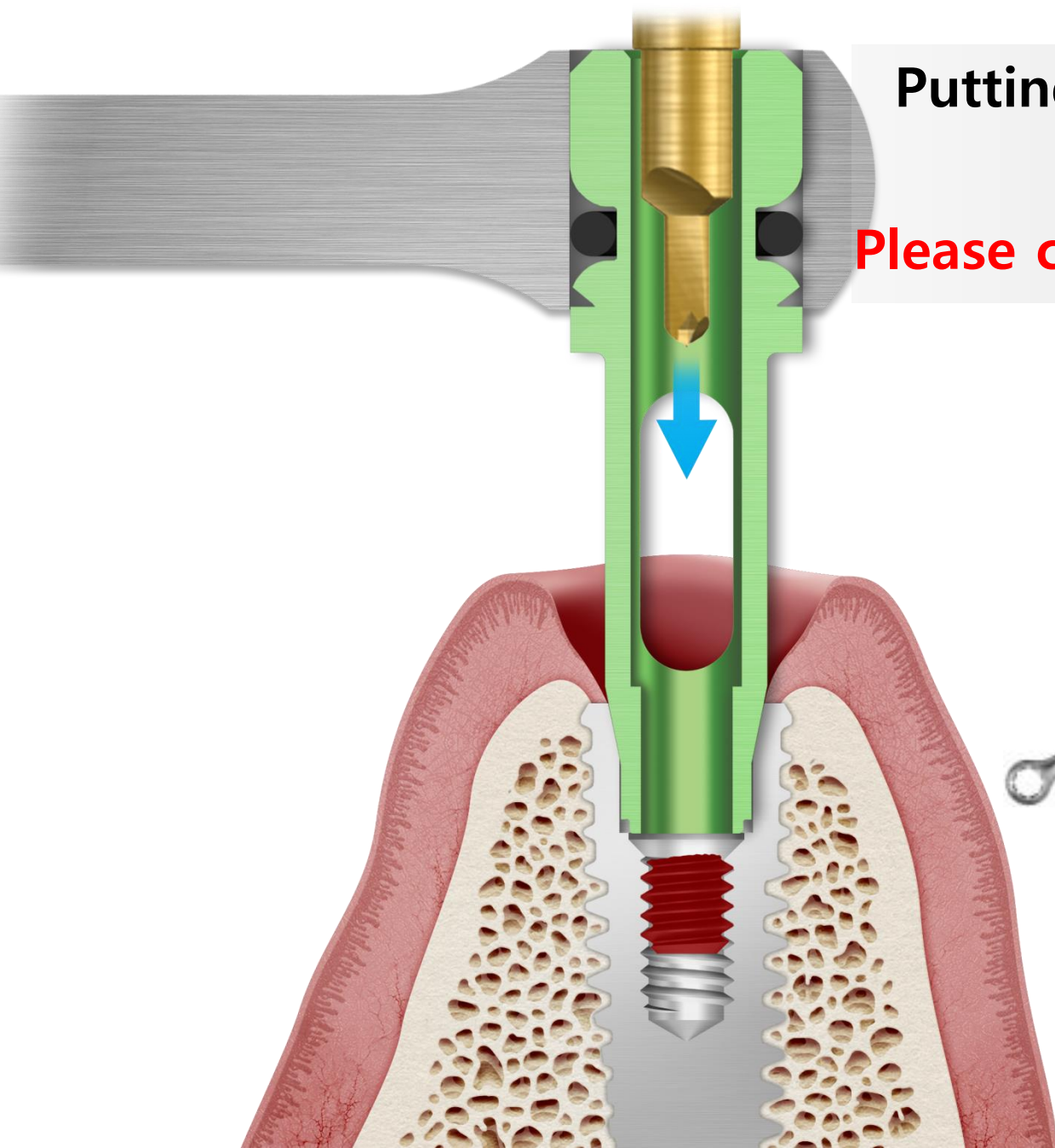

Putting "SR drill" inside the "Guide" Hole

Please check the platform!!!

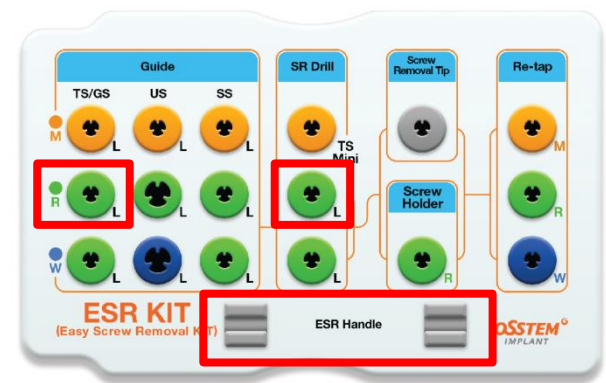

Putting "SR drill" inside the "Guide" Hole

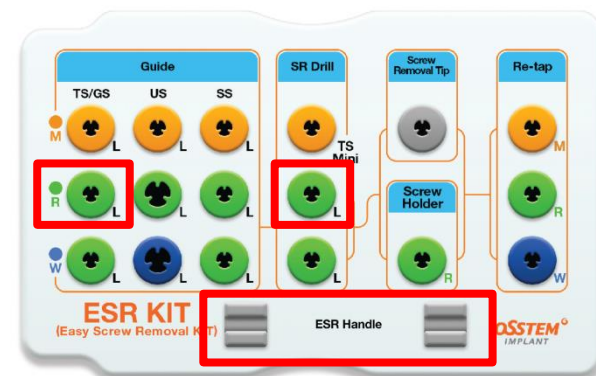
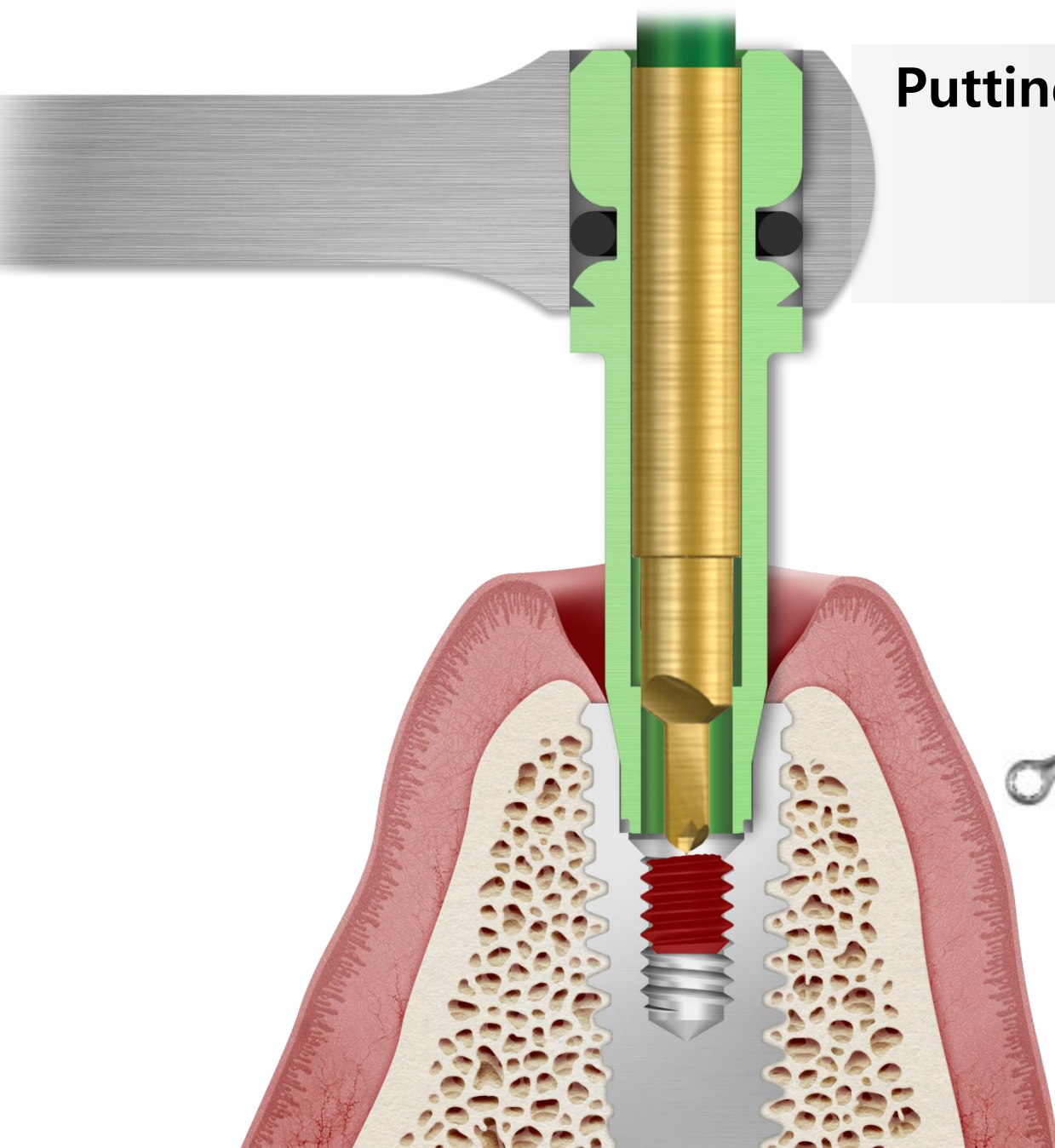

Turning "SR drill" to Counter-clockwise

- Irrigation & Suction
- Rpm:1200~1500

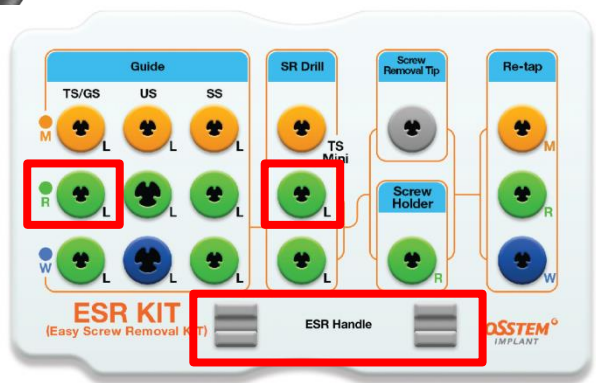
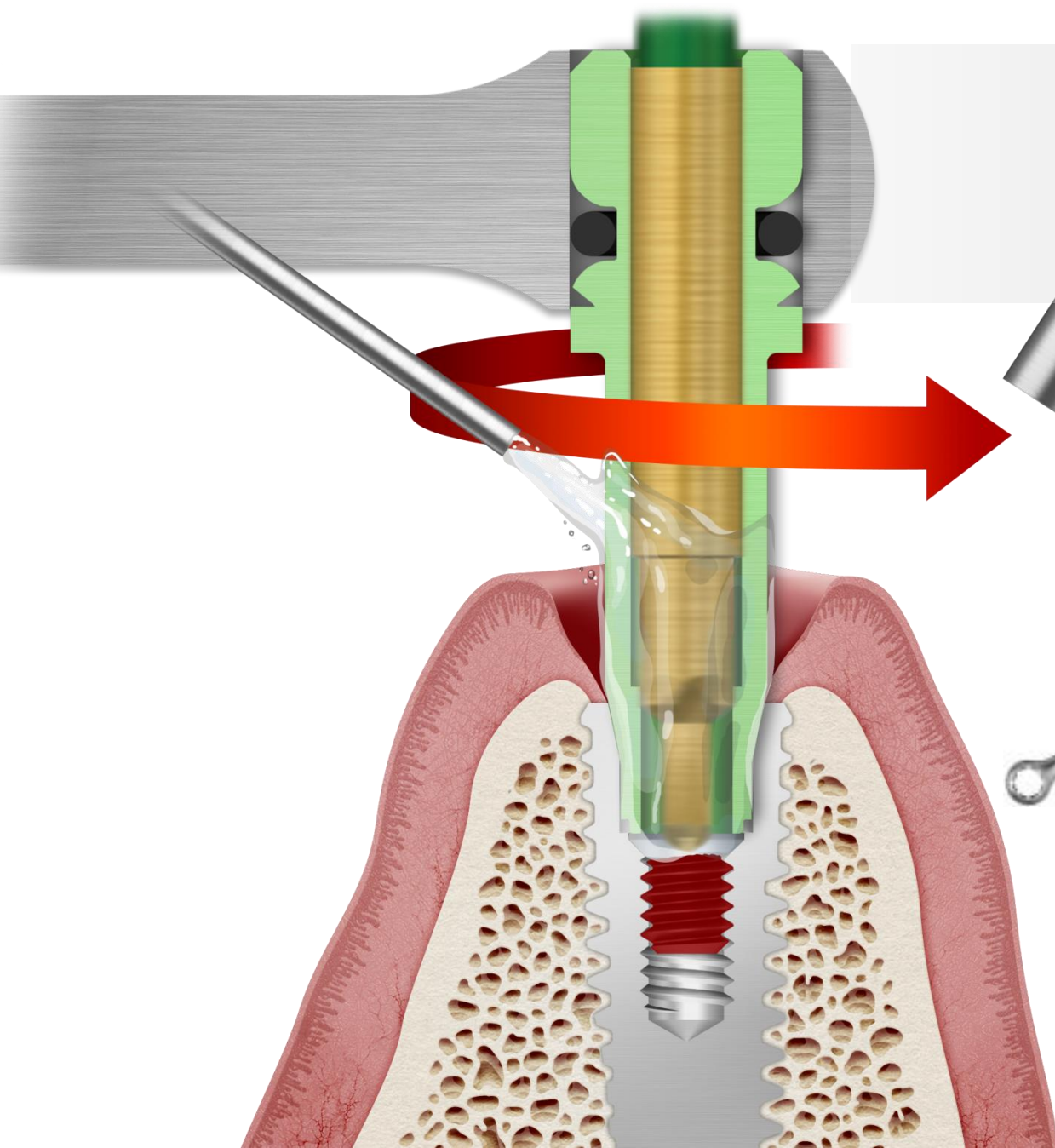

Turning "SR drill" to Counter-clockwise

- Irrigation & Suction
- Rpm:1200~1500

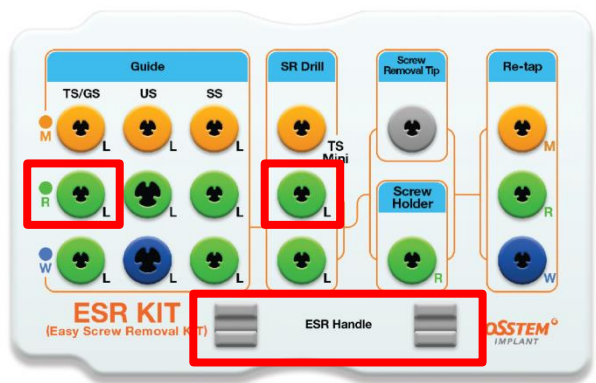
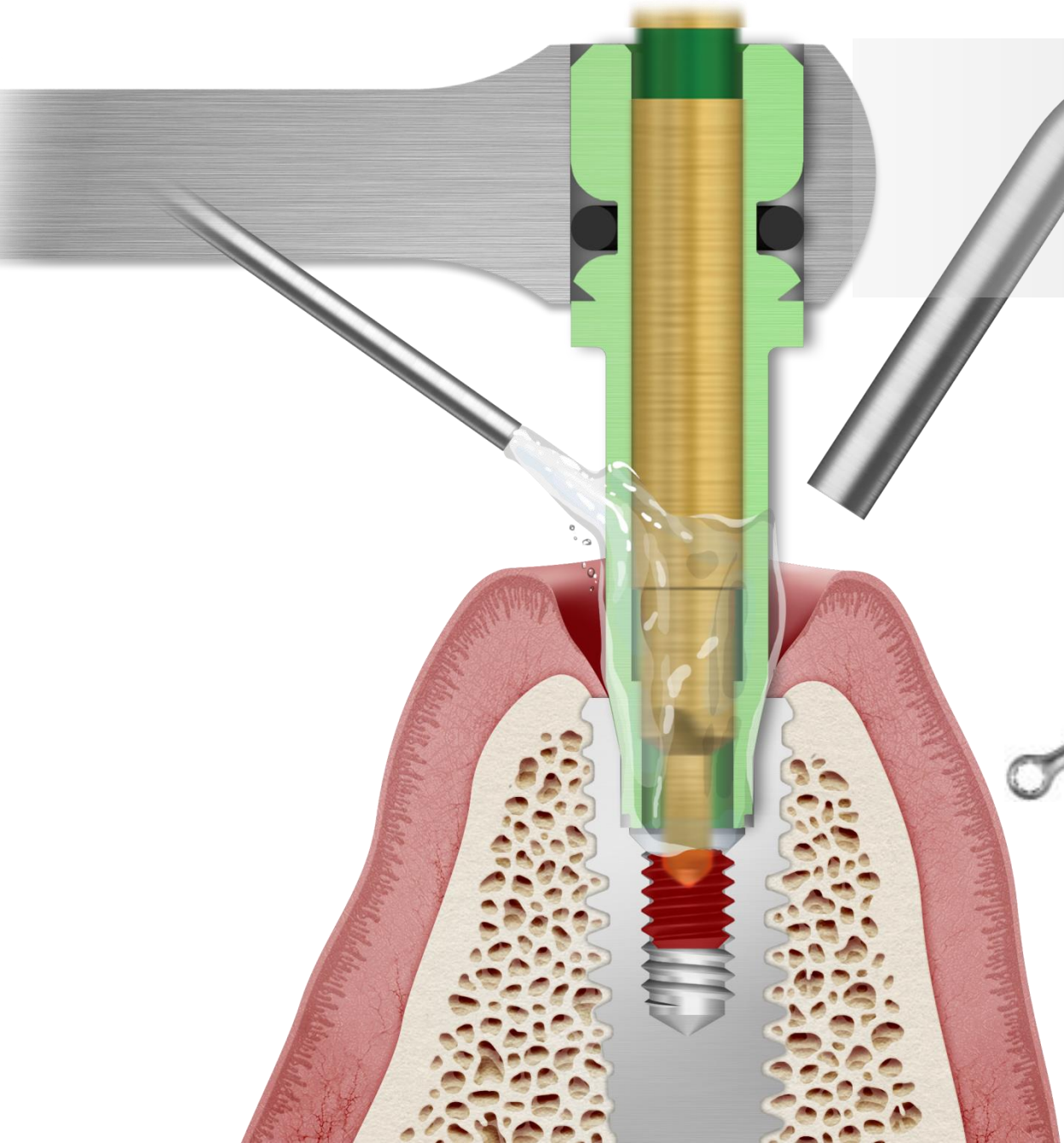

Turning "SR drill" to Counter-clockwise

- Irrigation & Suction
- Rpm:1200~1500

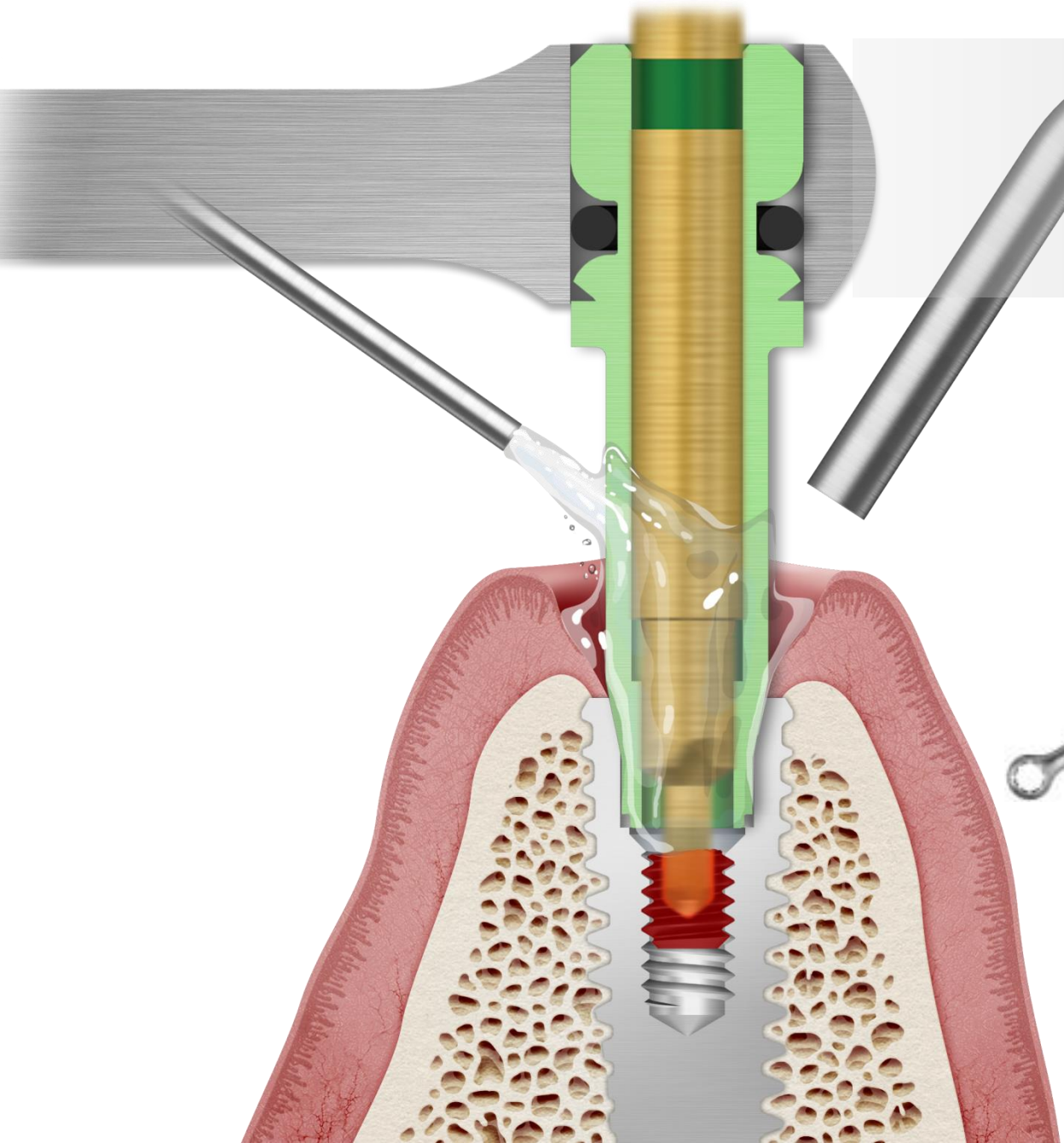

ESR KIT
(Easy Screw Removal KIT)

ESR Handle

OSSTEM[®]
IMPLANT



Turning "SR drill" to Counter-clockwise

- Irrigation & Suction
- Rpm:1200~1500

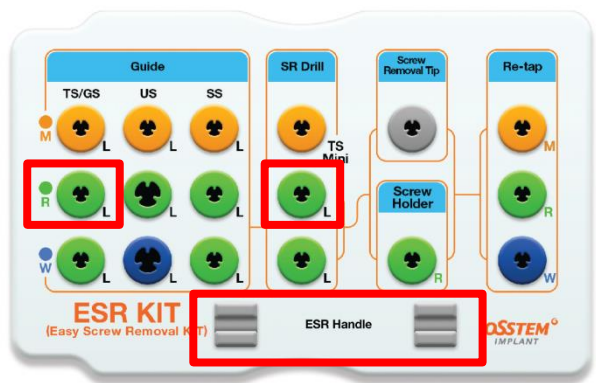
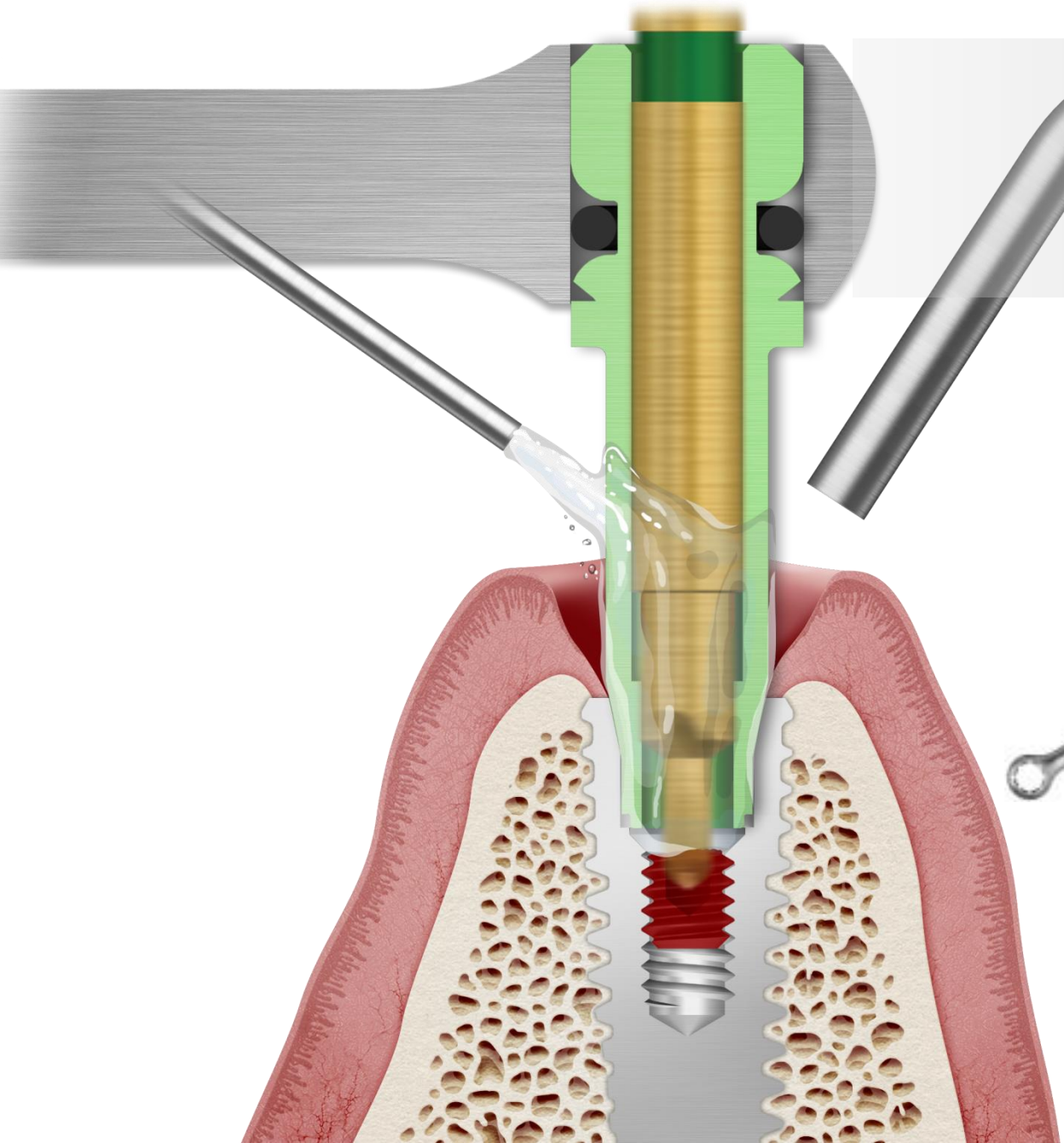

Separating "SR Drill"

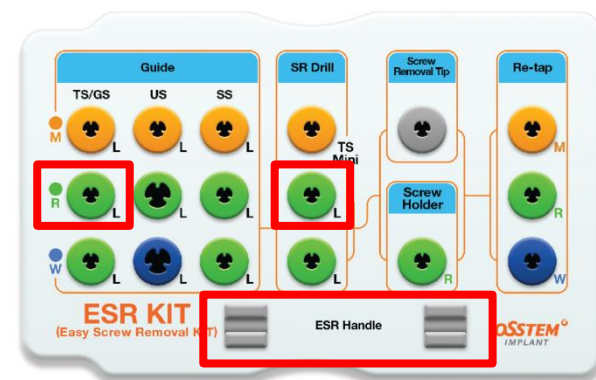
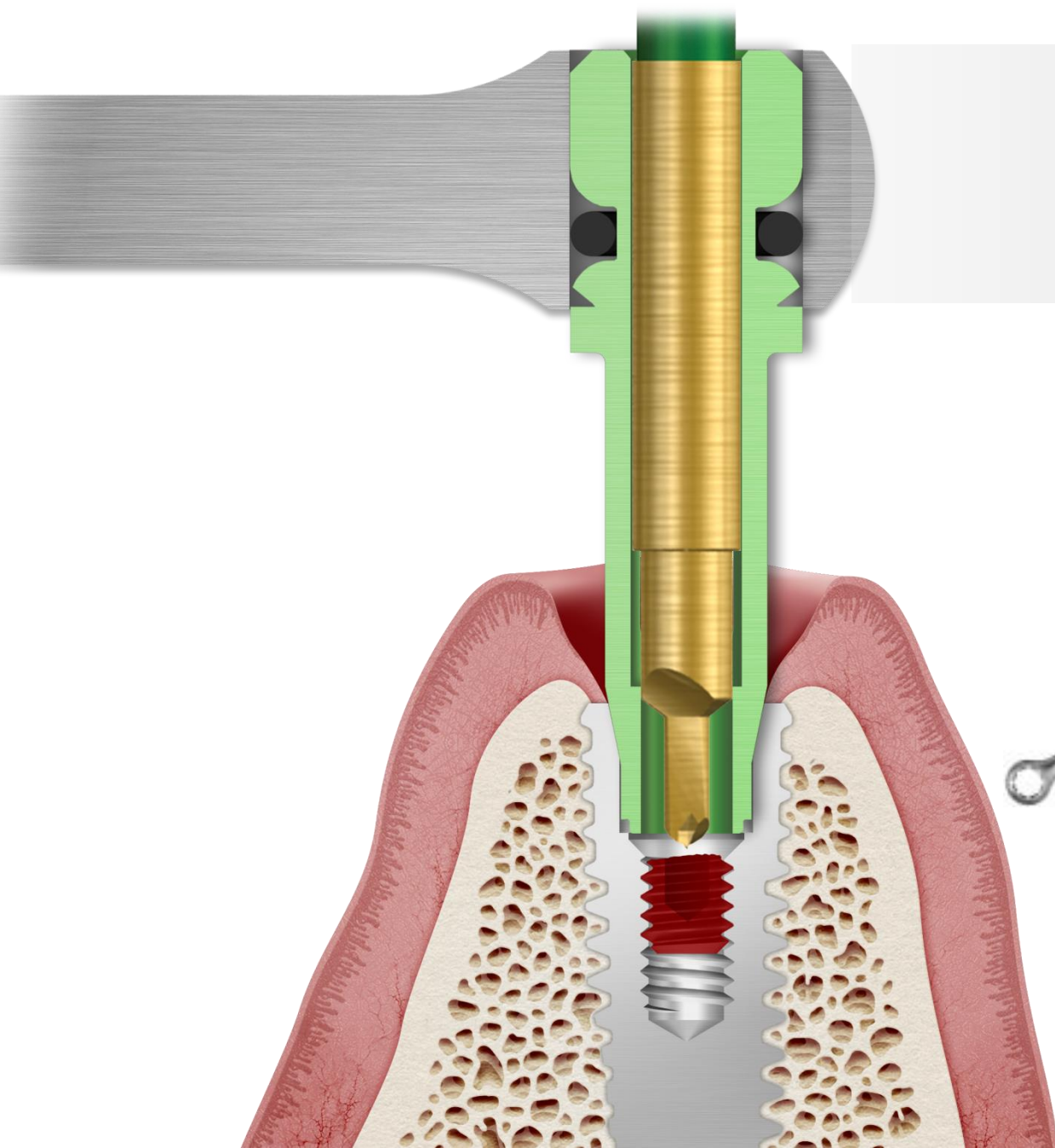

Separating "SR Drill"

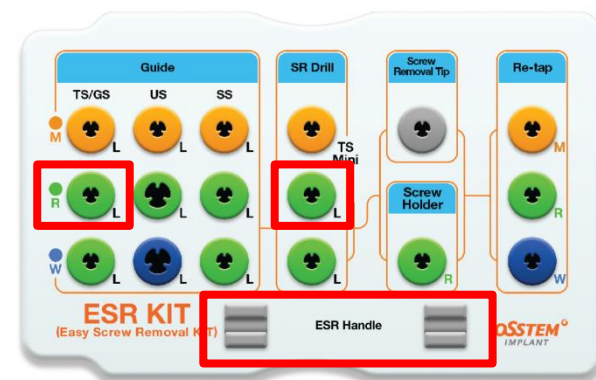
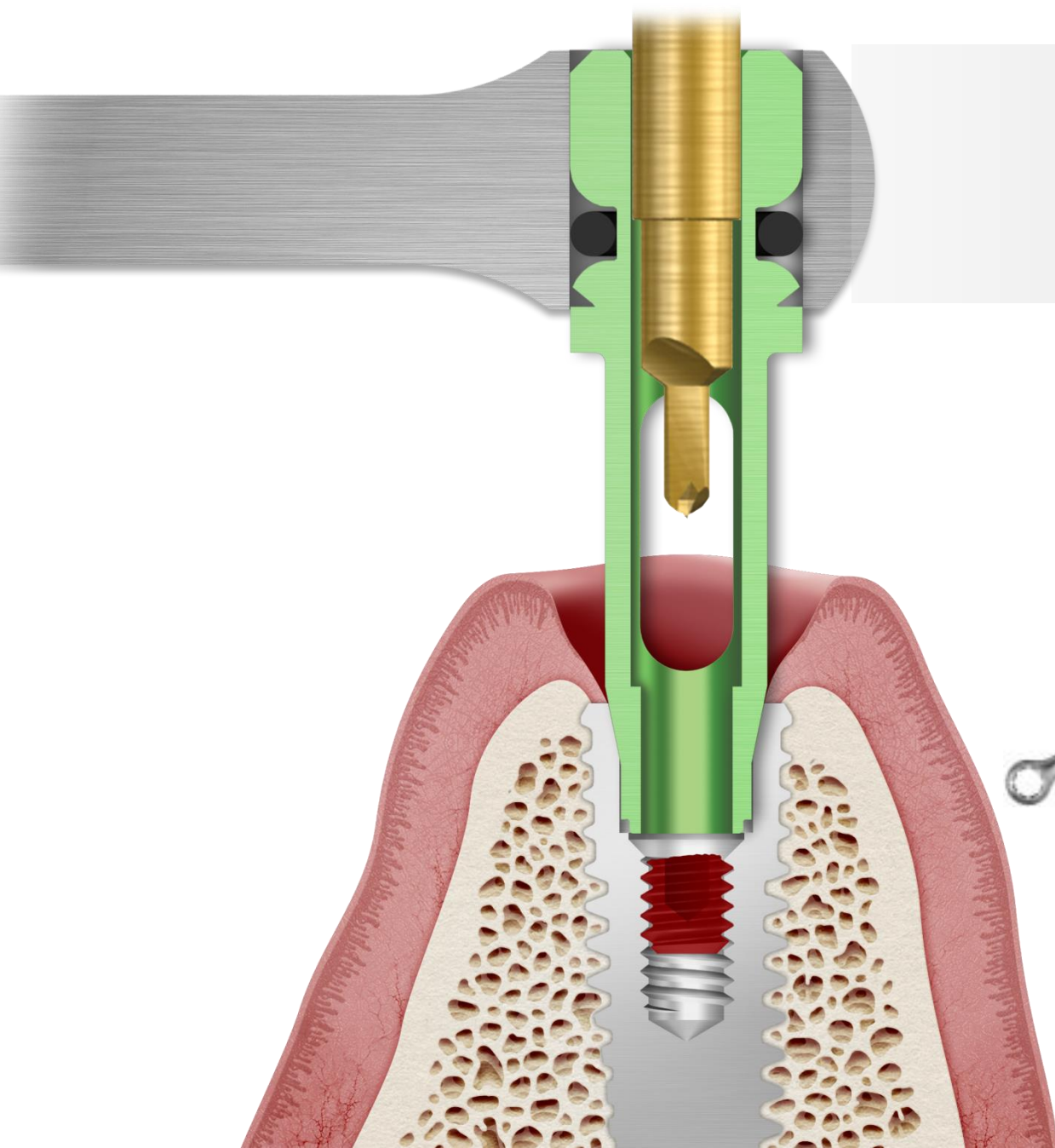

Separating "SR Drill"

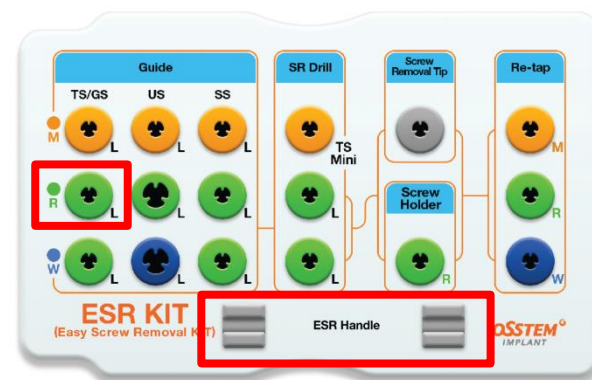
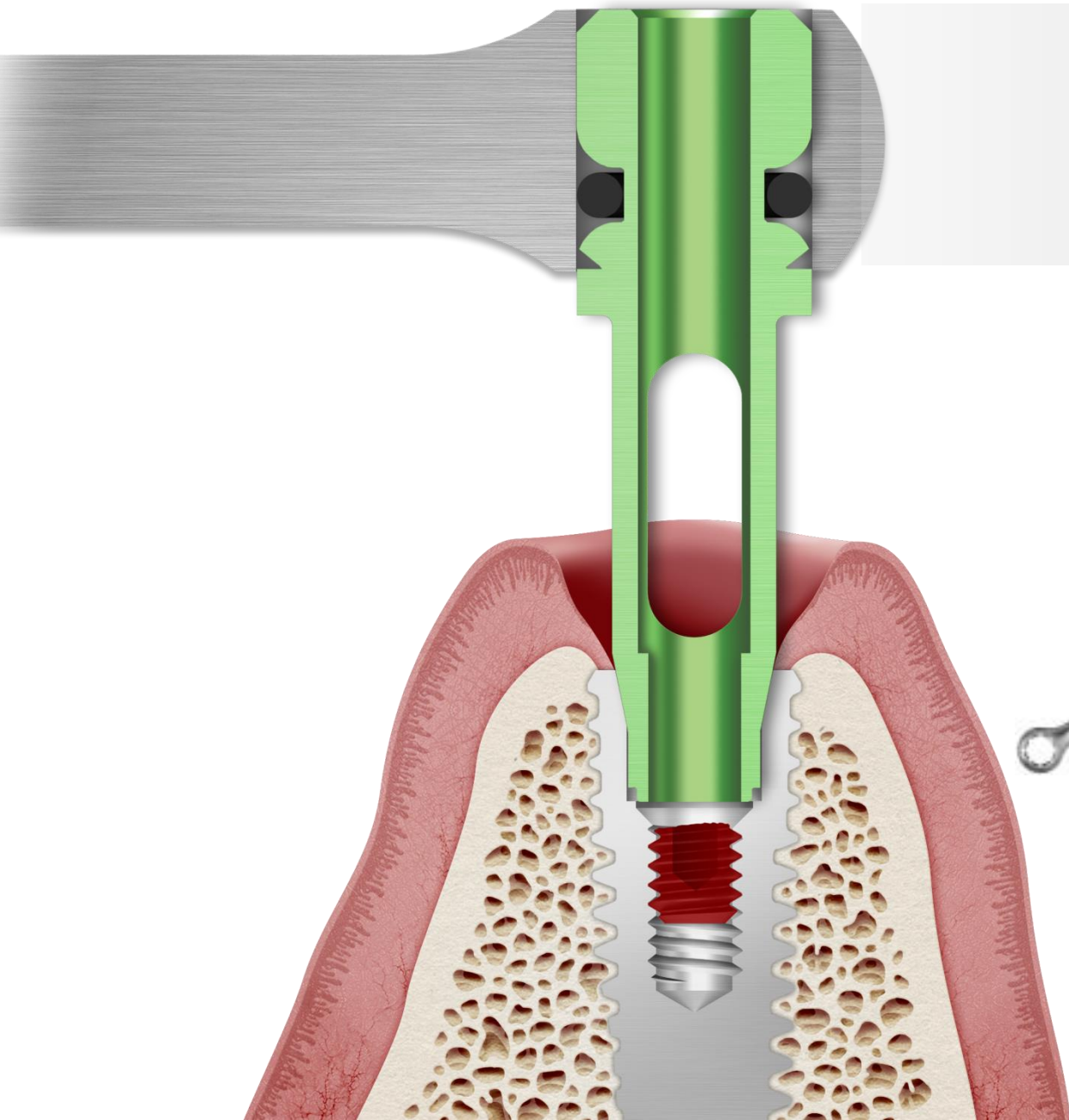

Separating "ESR Handle"

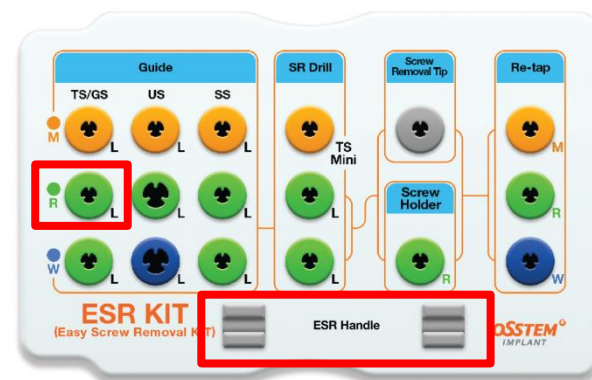
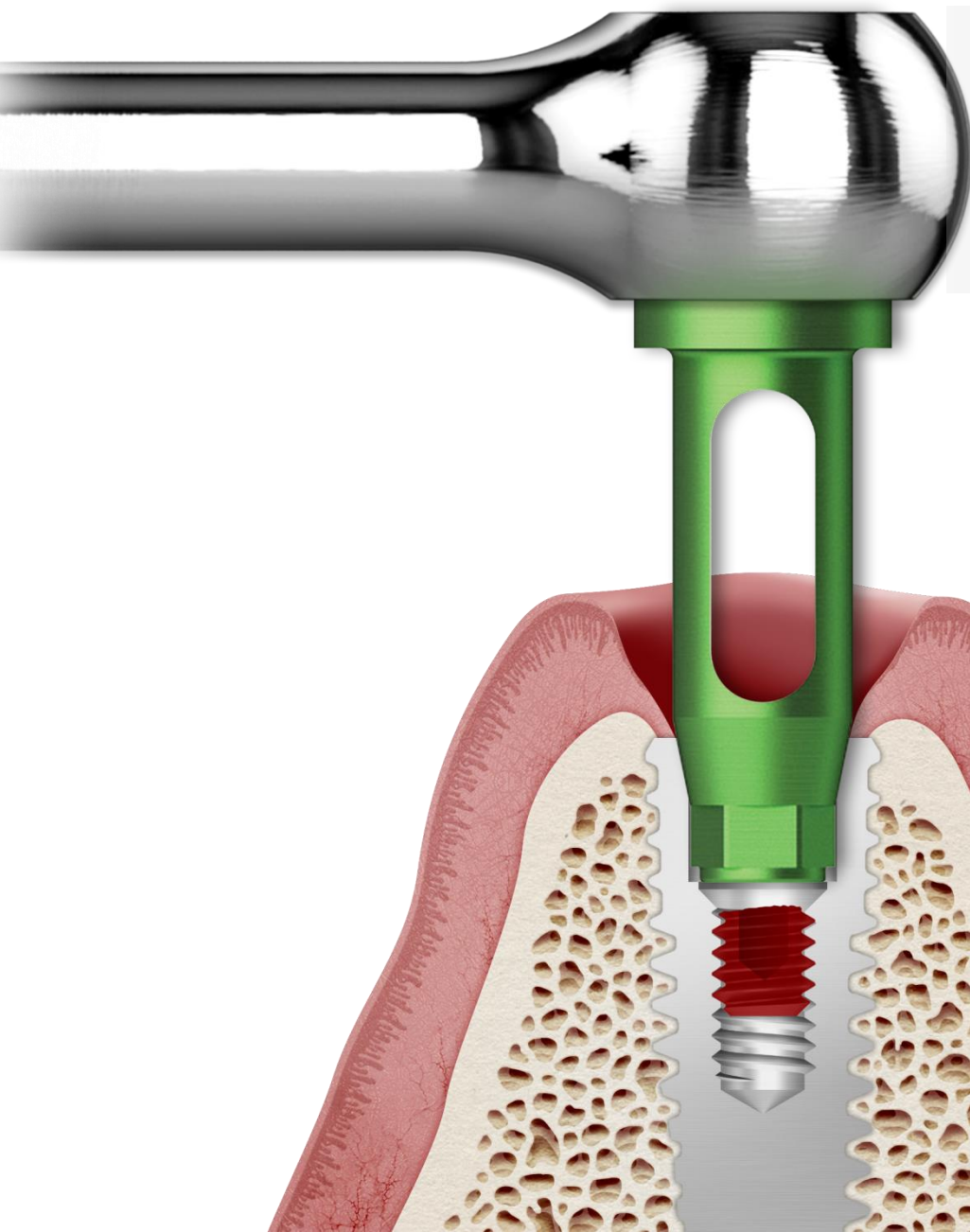

Separating "ESR Handle"

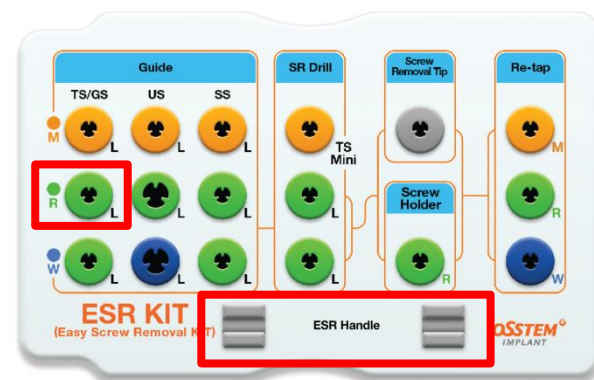
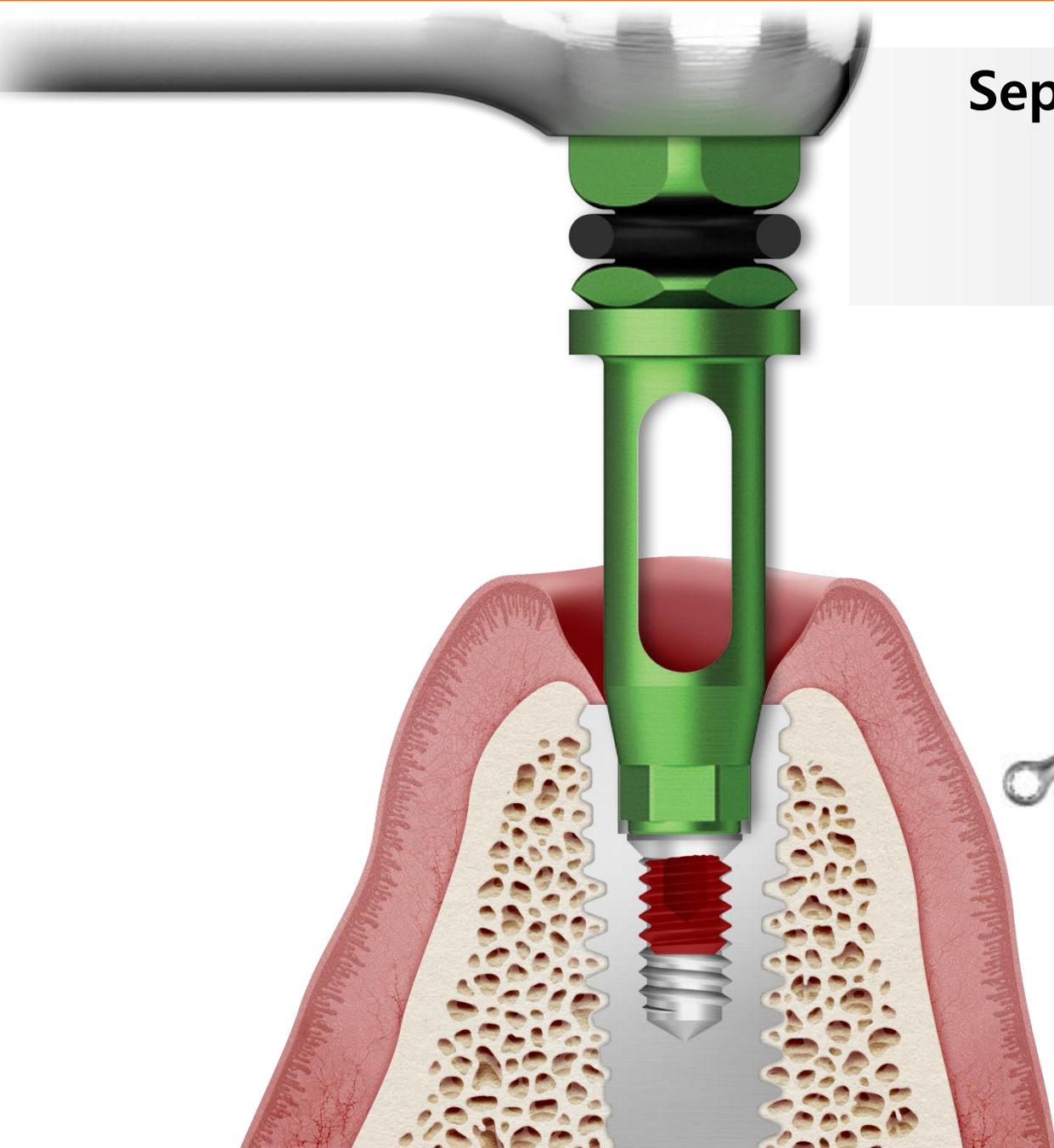

Separating "Guide"

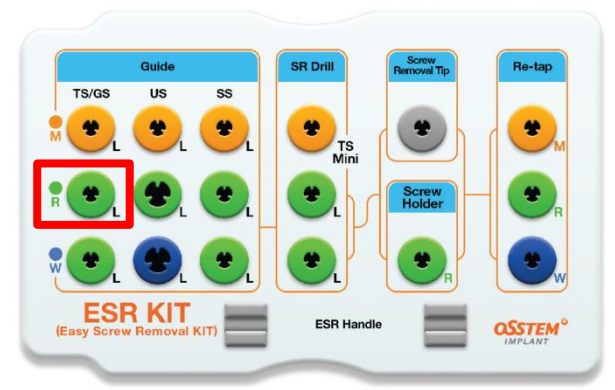
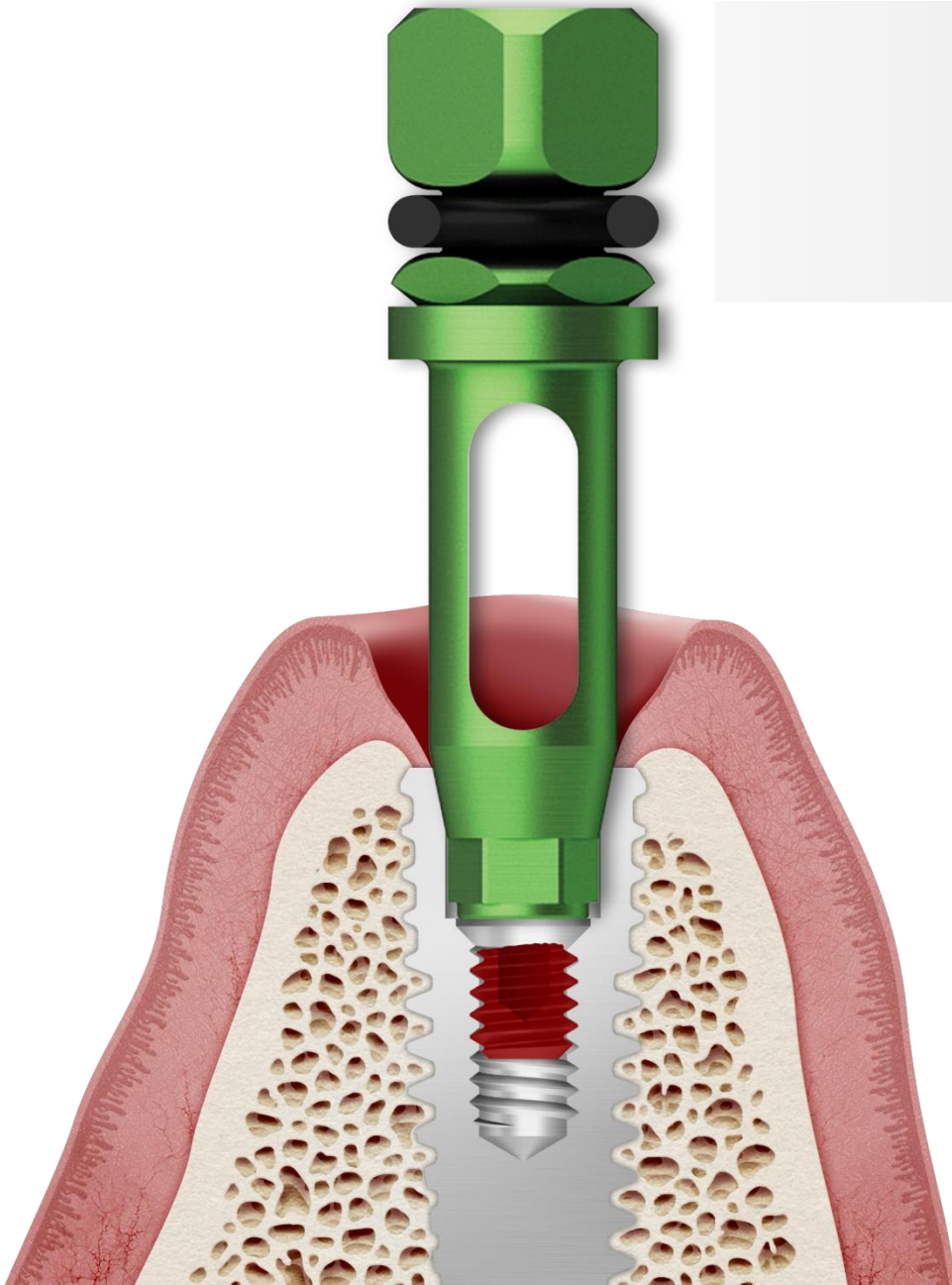

Separating "Guide"

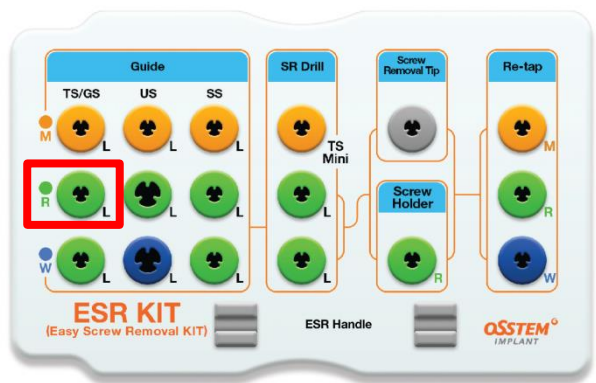
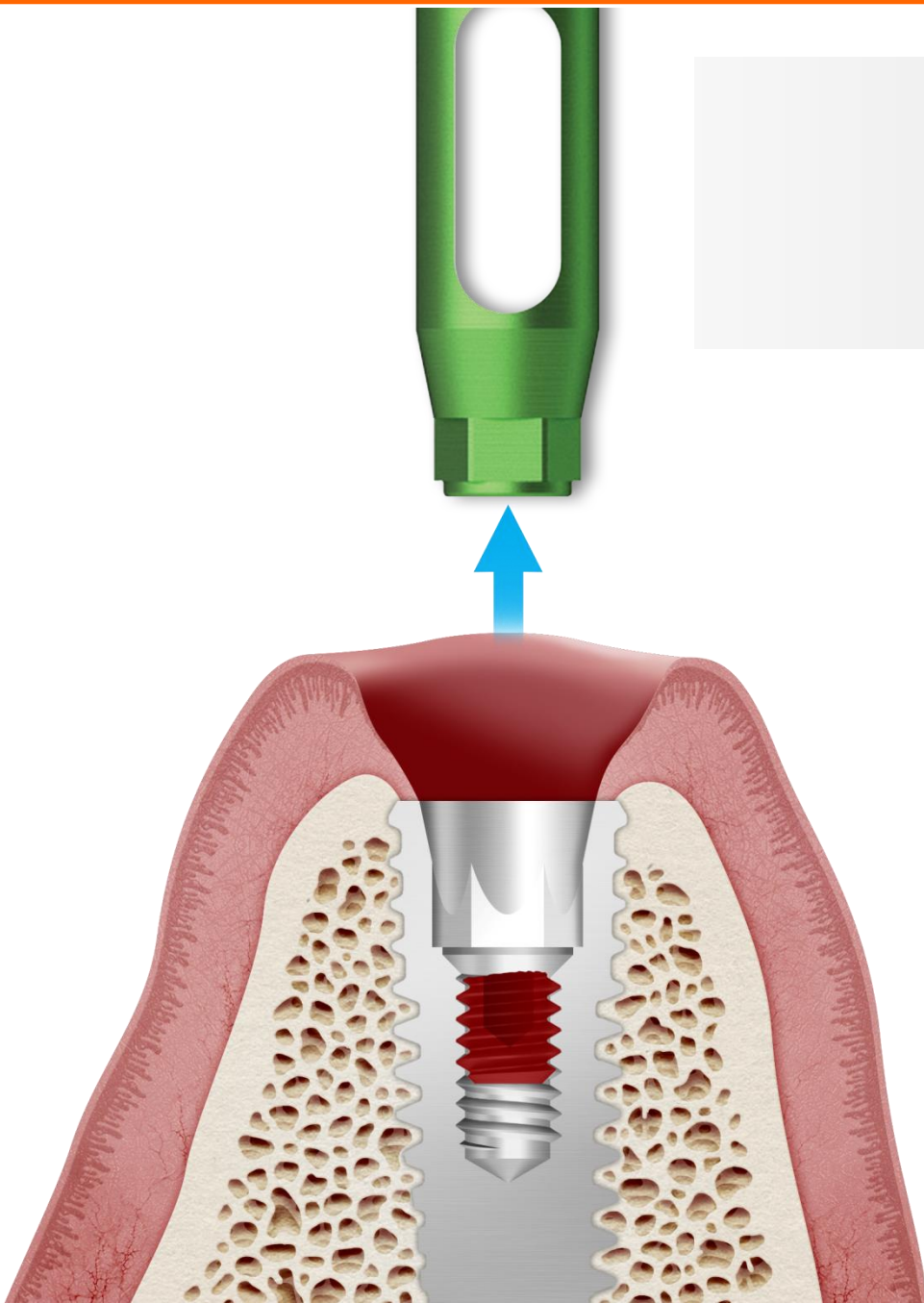

**After irrigation, remove
remaining Chip using the
Suction**

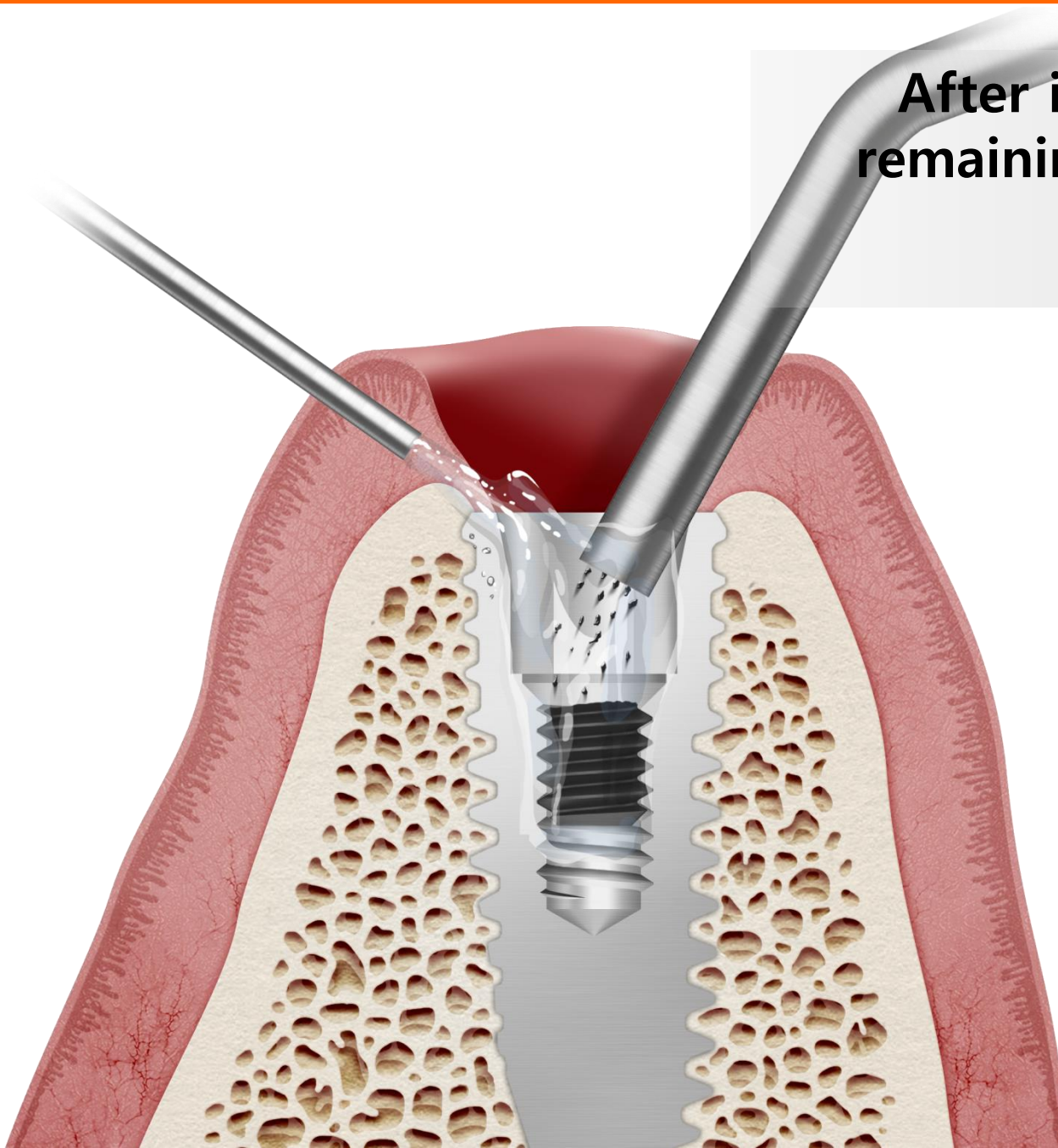

"Guide" reconnection

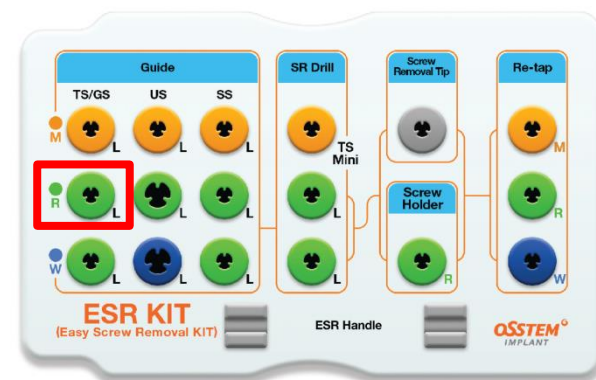
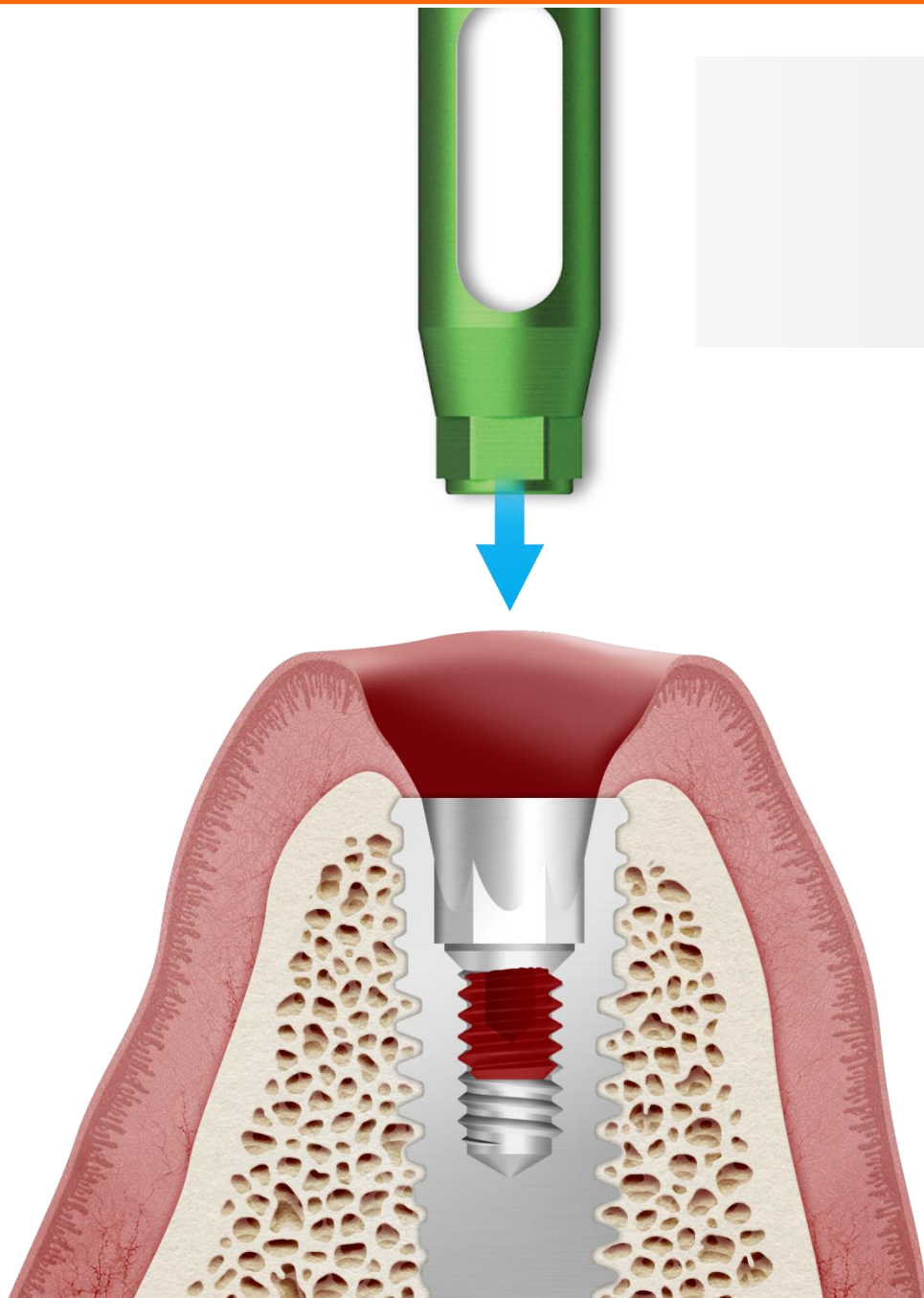

"Guide" reconnection

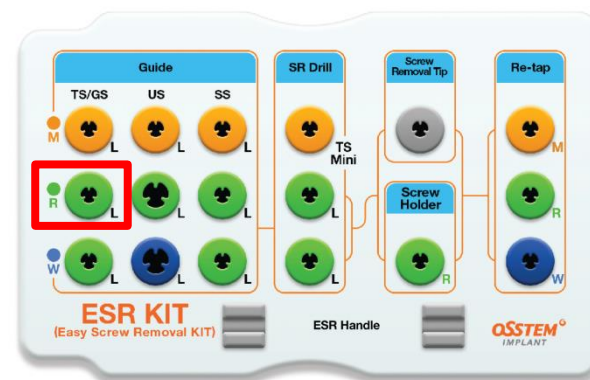
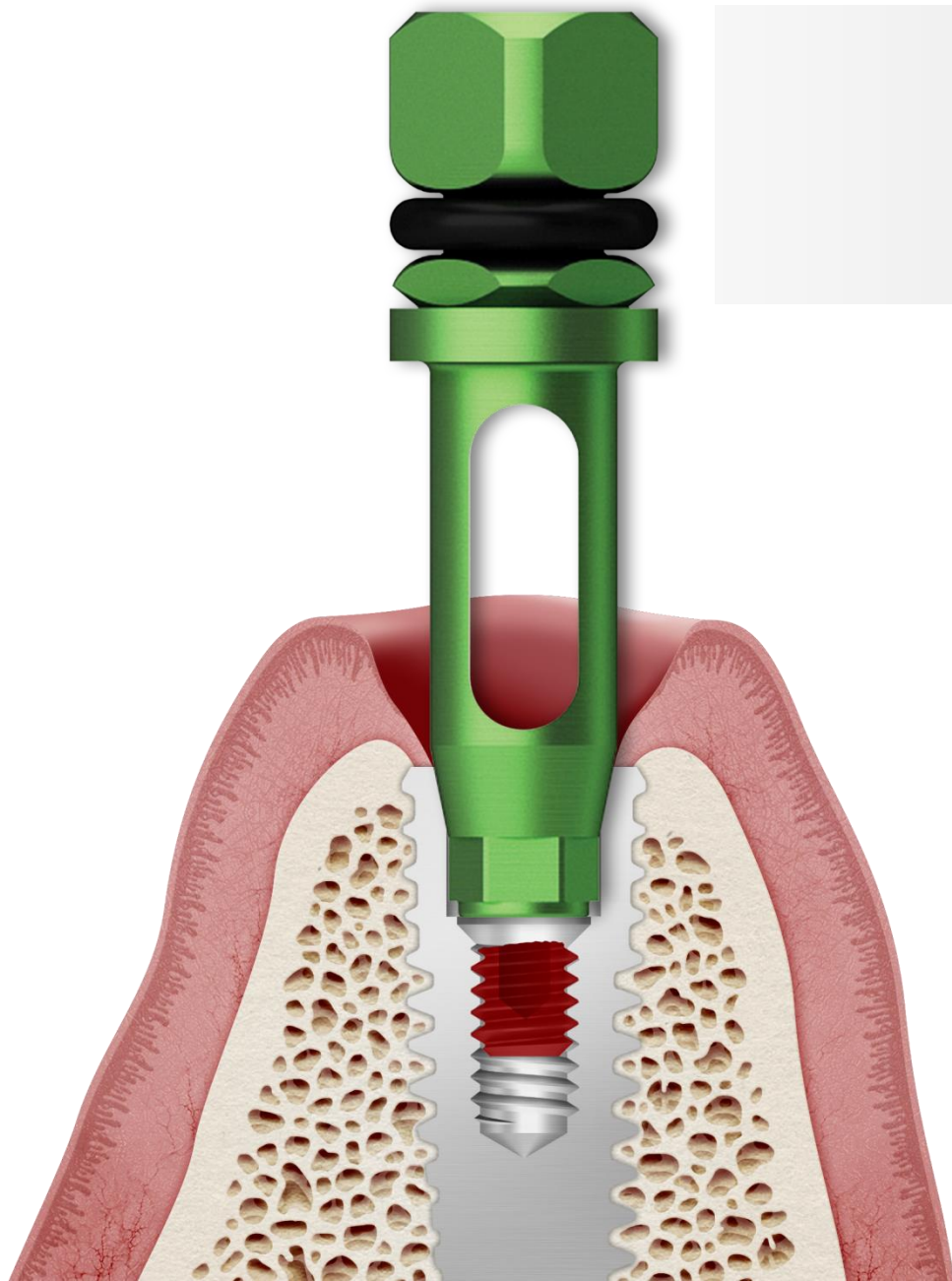

Reconnecting "ESR Handle" to "Guide"

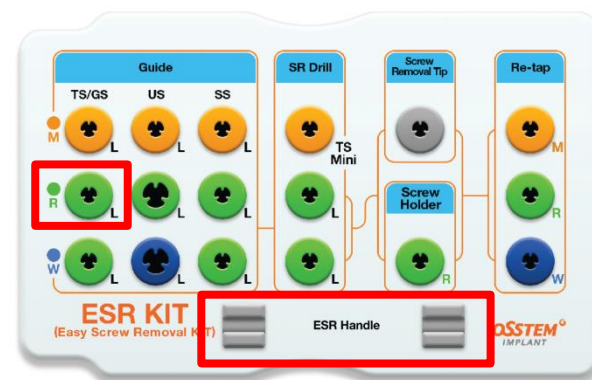
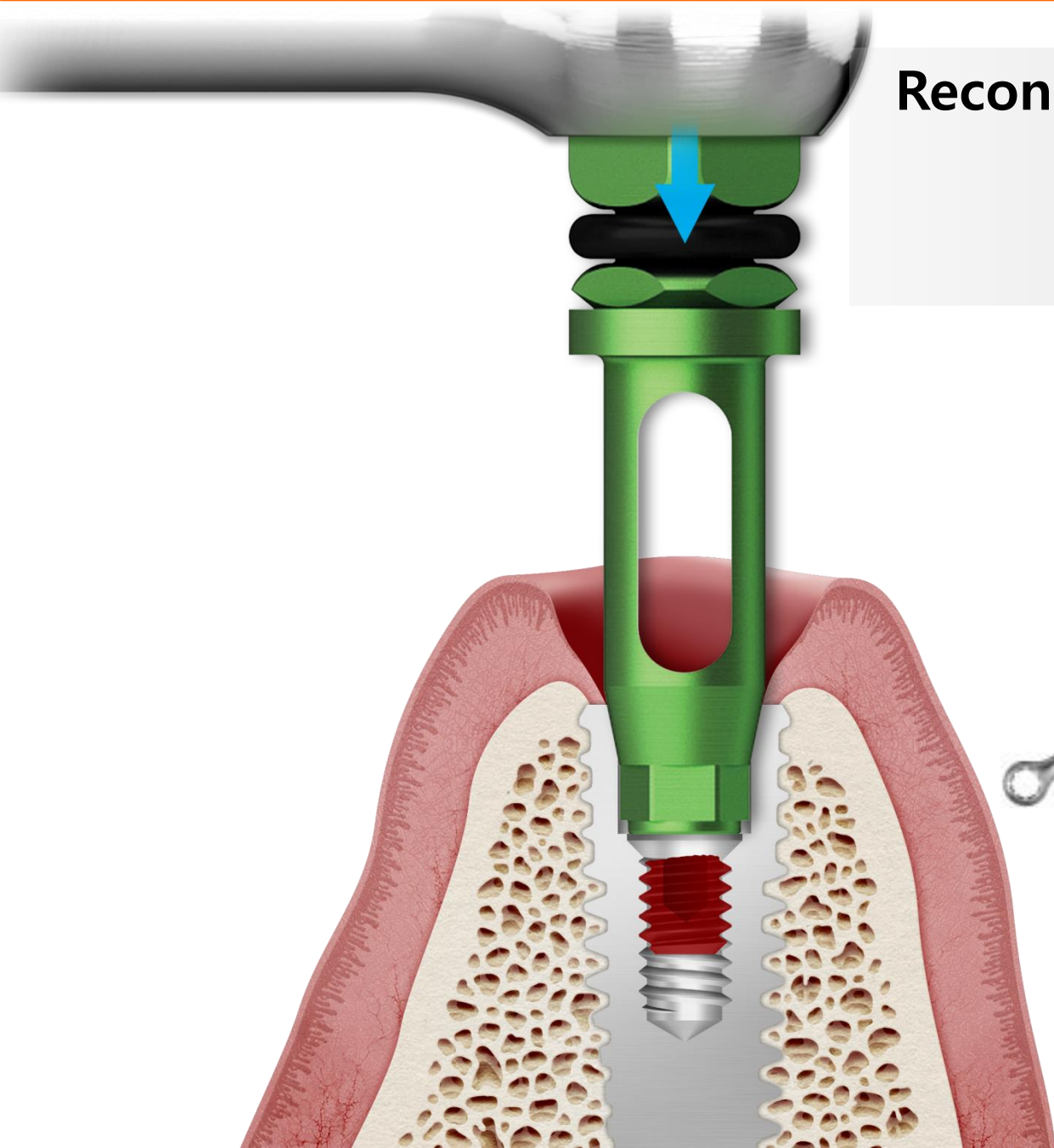

Reconnecting "ESR Handle" to "Guide"

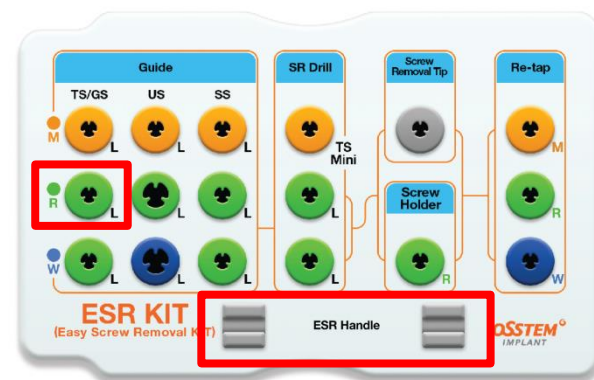
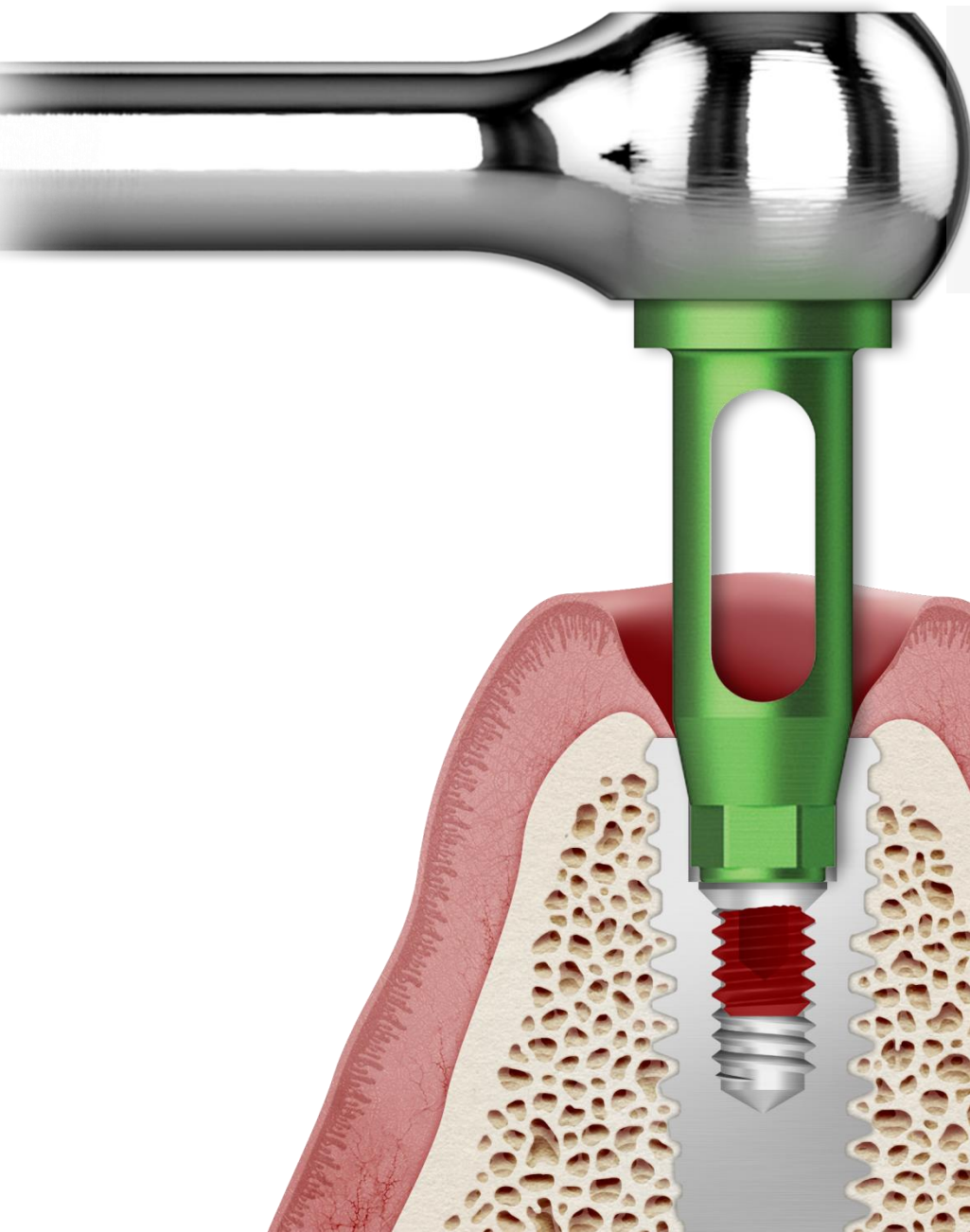

Reconnecting "ESR Handle" to "Guide"

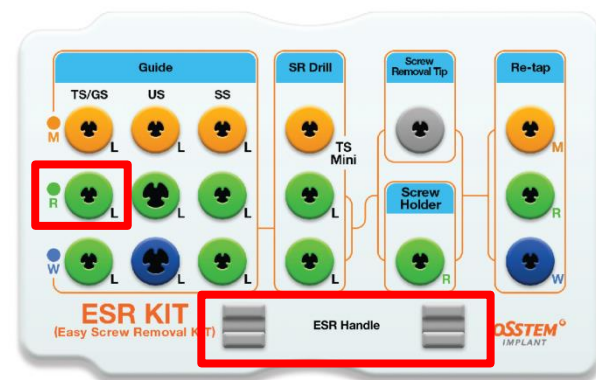
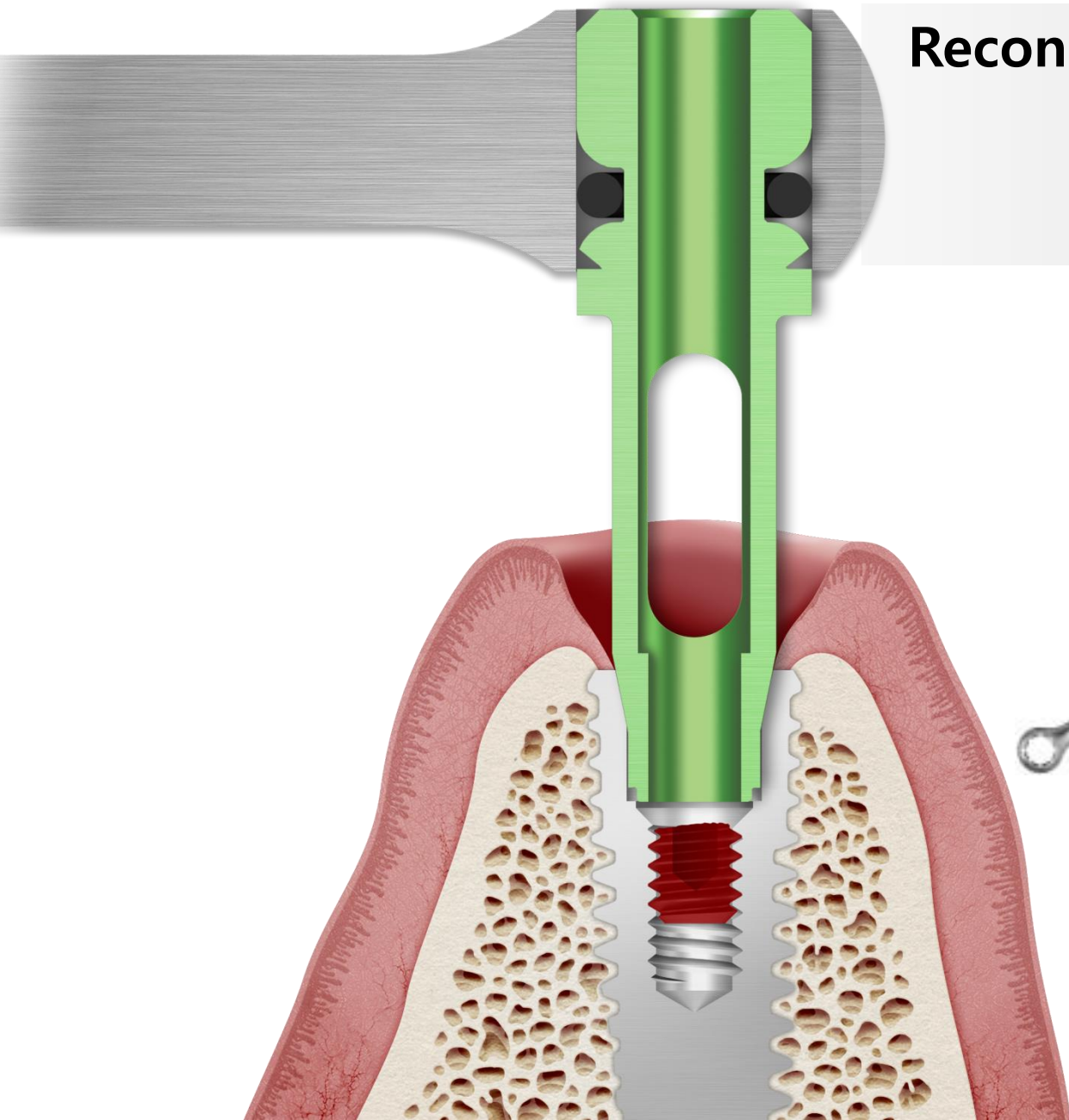

Putting "SR Tip" inside the "Guide"

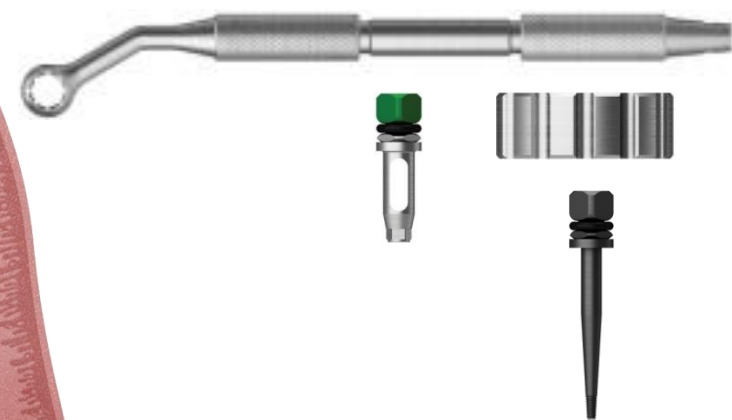
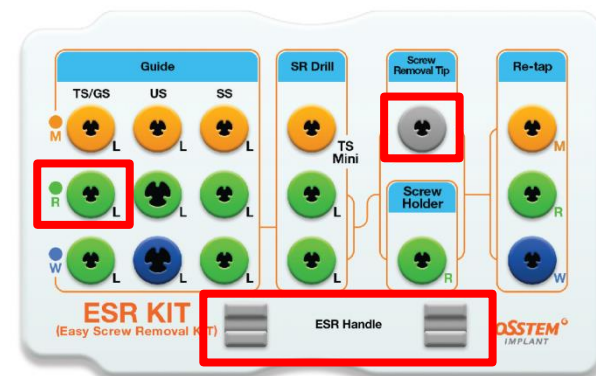
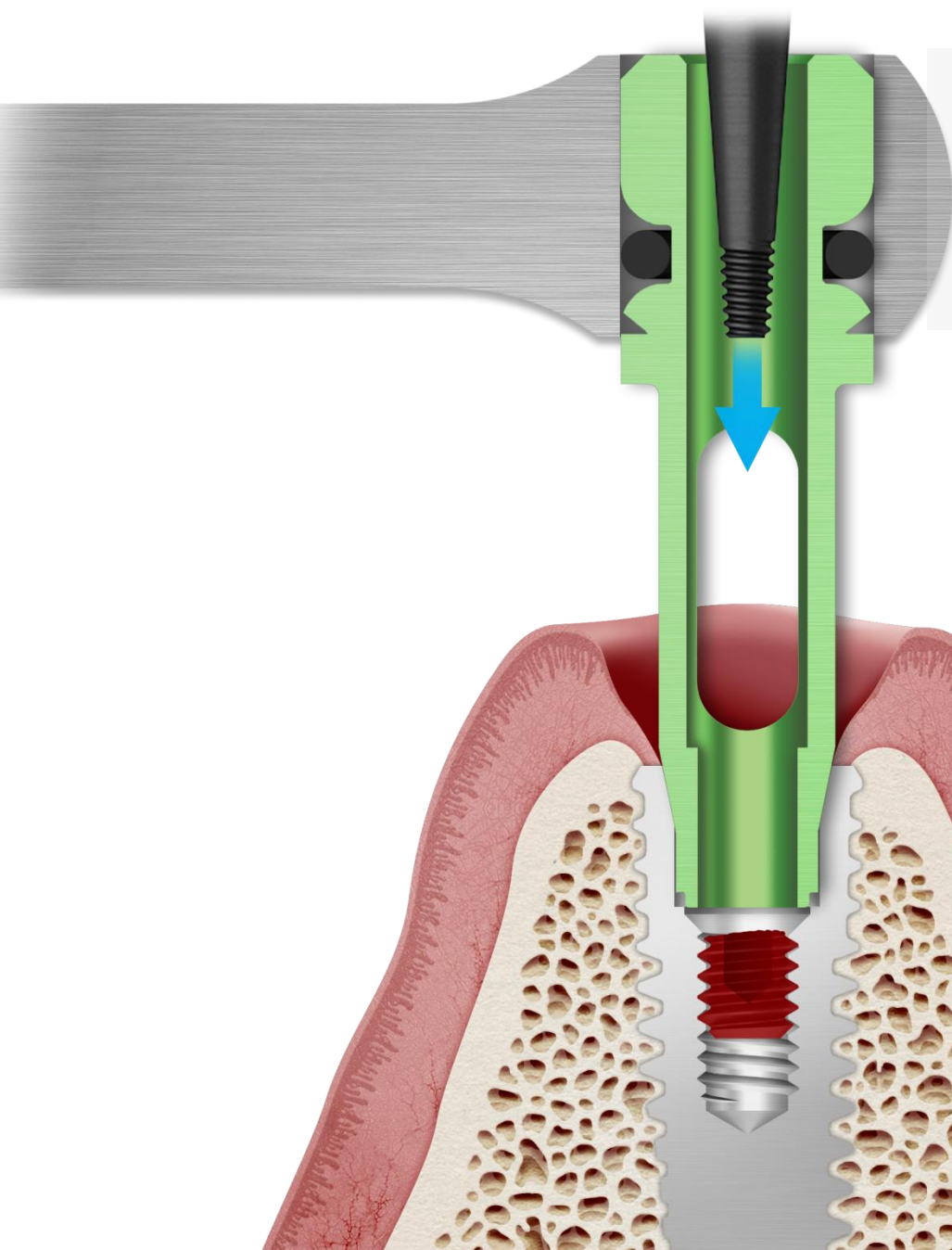

Putting "SR Tip" inside the "Guide"

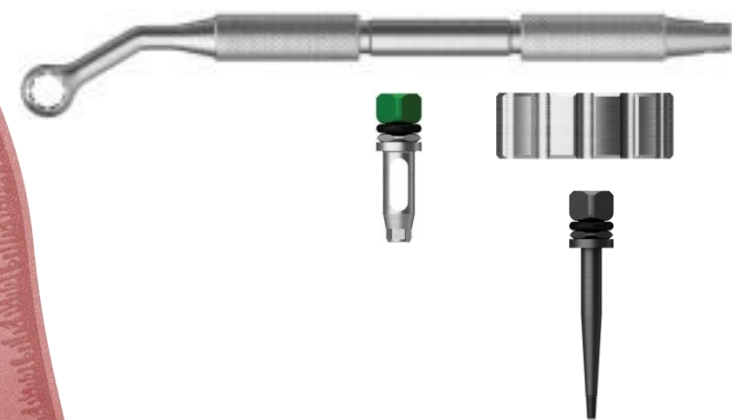
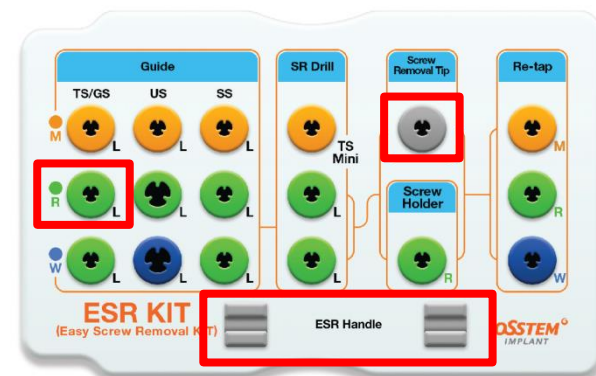
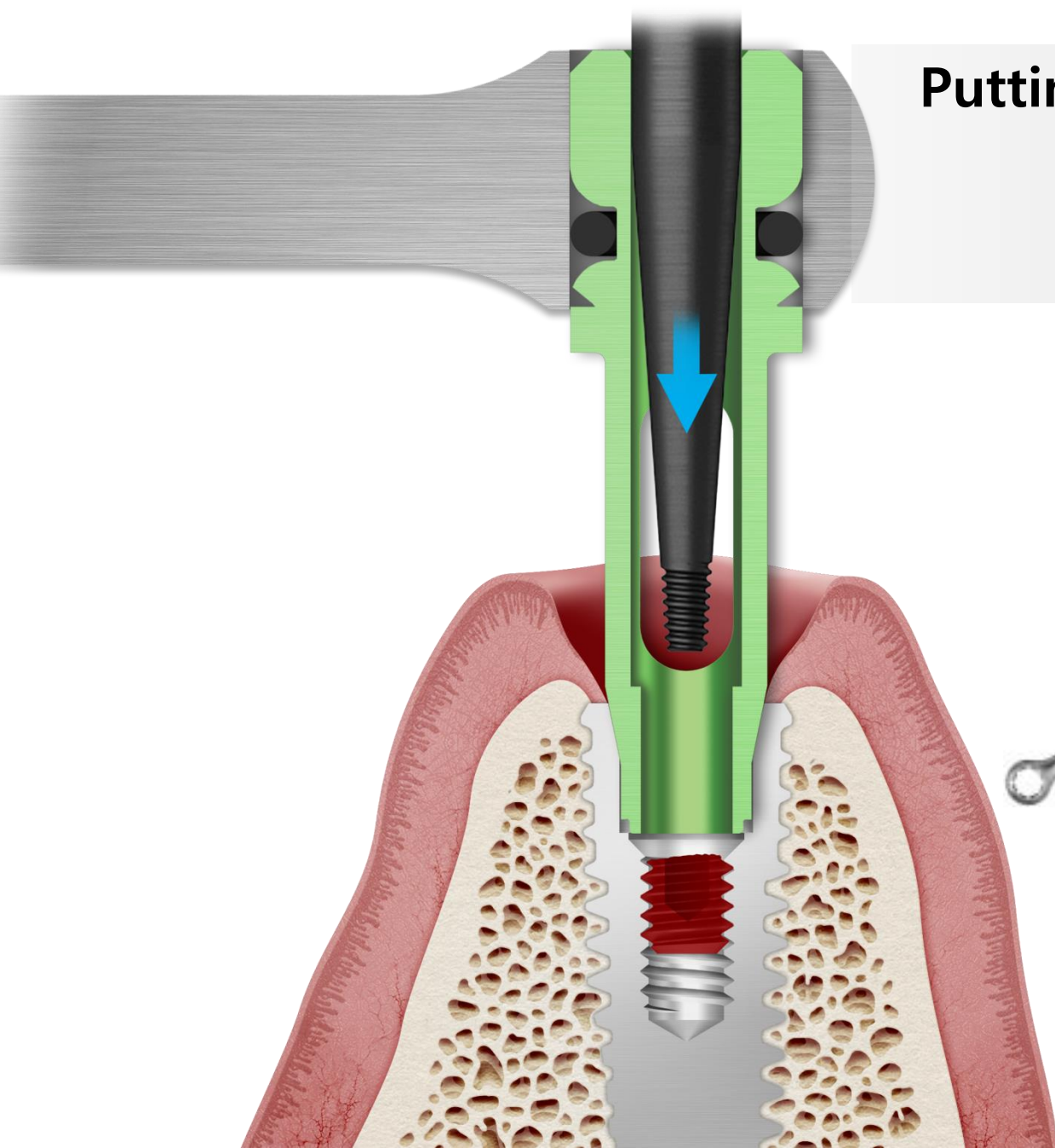

Putting "SR Tip" inside the "Guide"

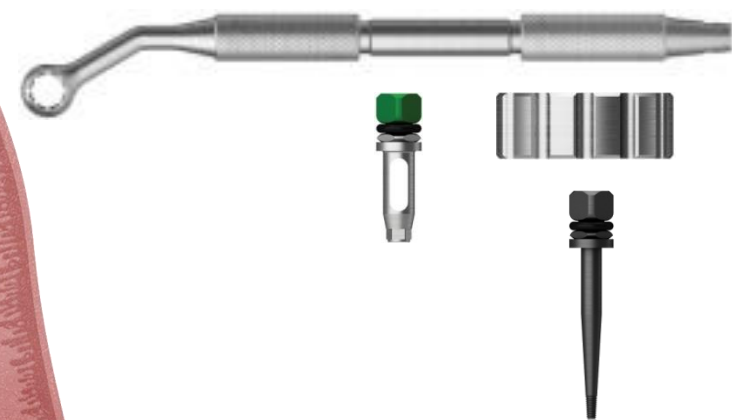
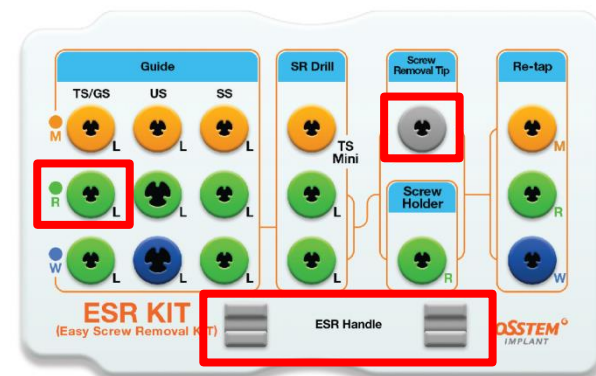
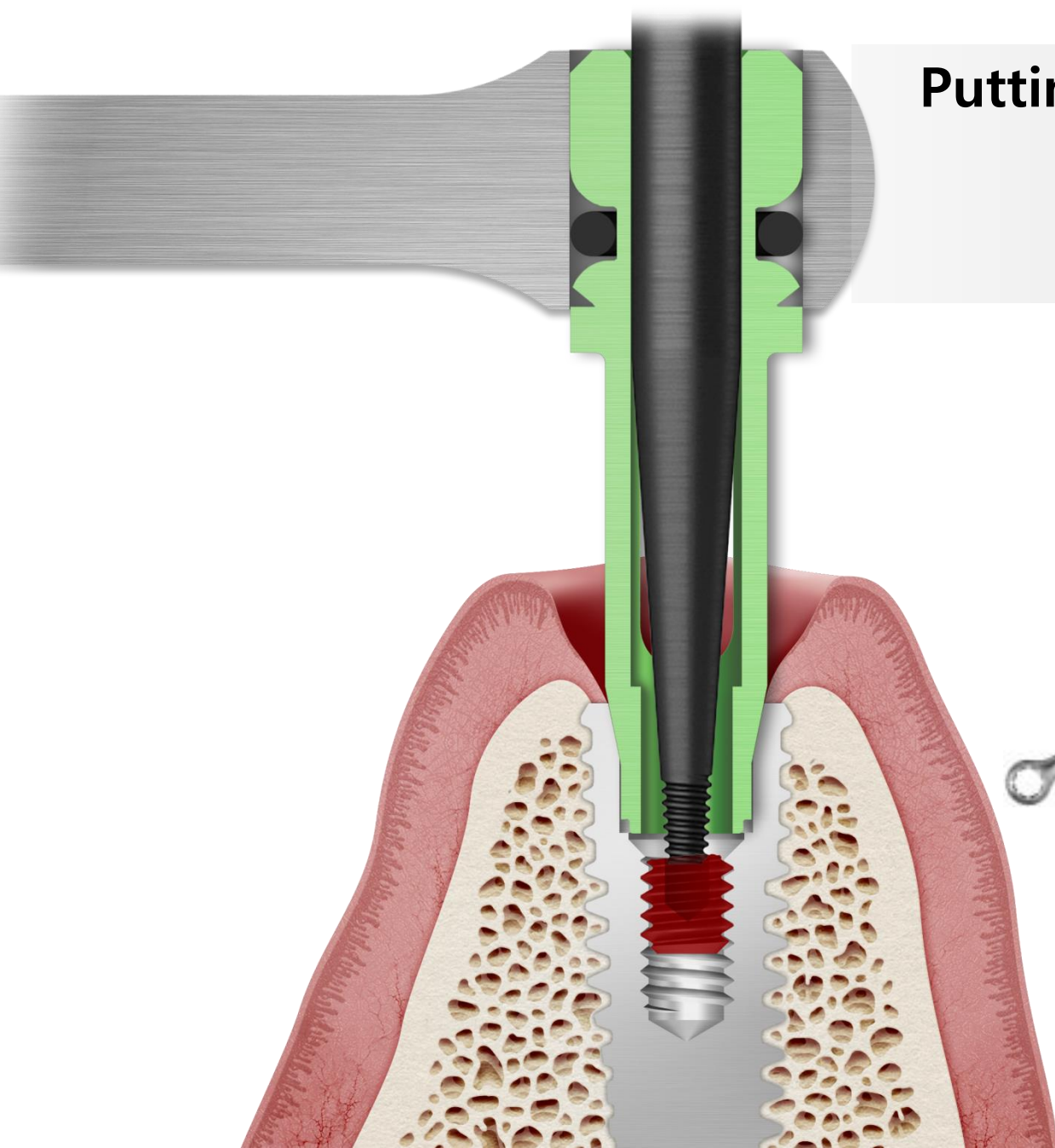

Removing fractured screw by turning "SR Tip" to counter-clockwise

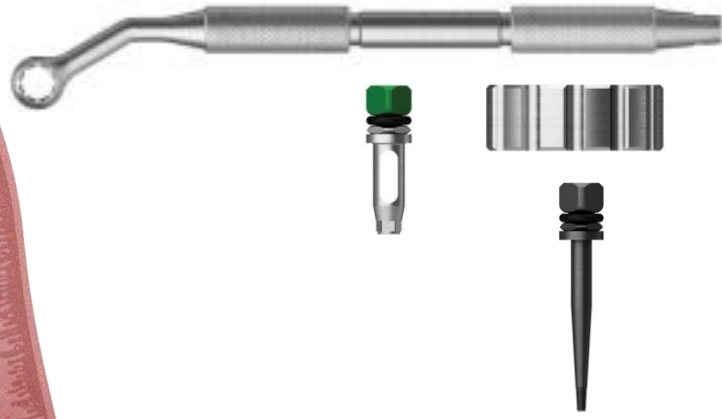
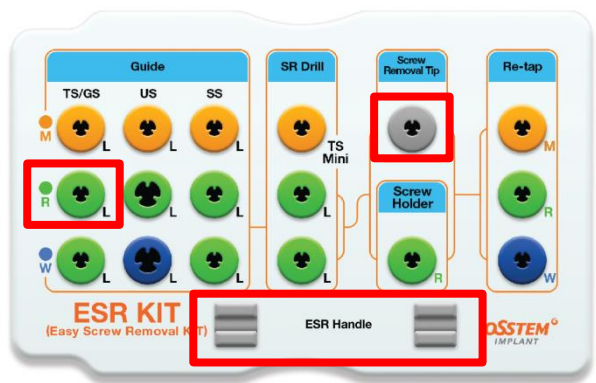
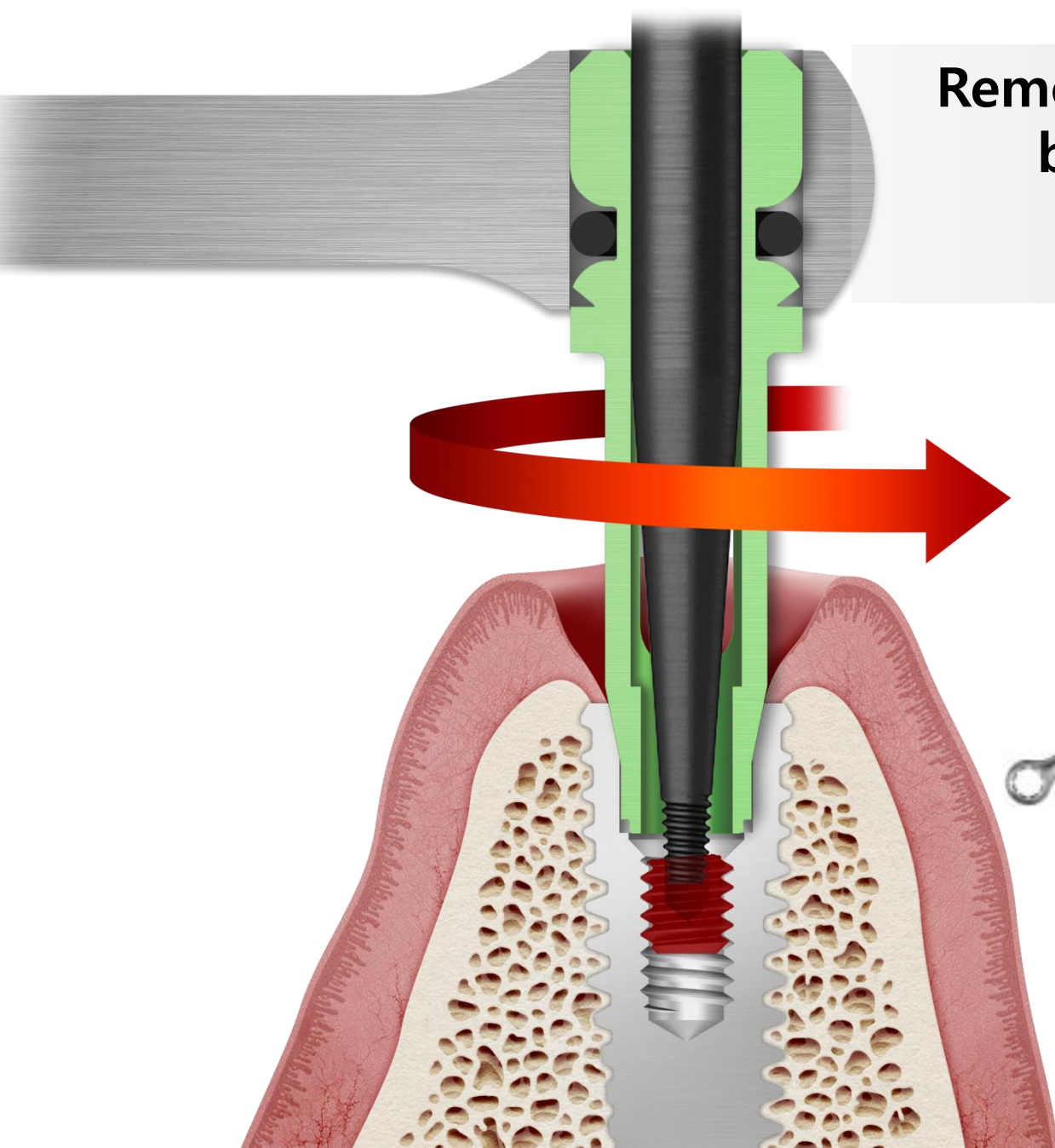

Removing fractured screw by turning "SR Tip" to counter-clockwise

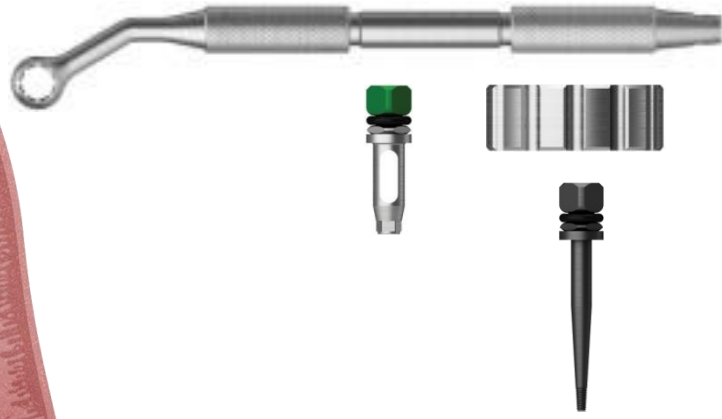
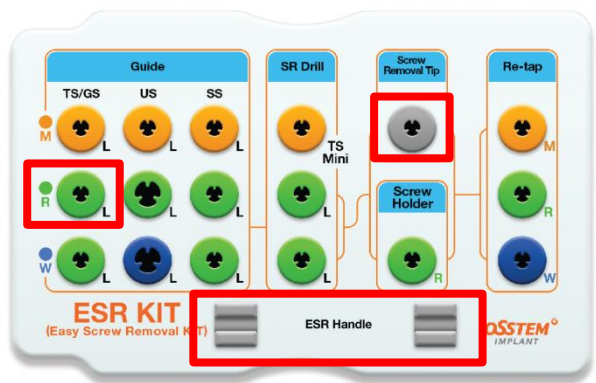
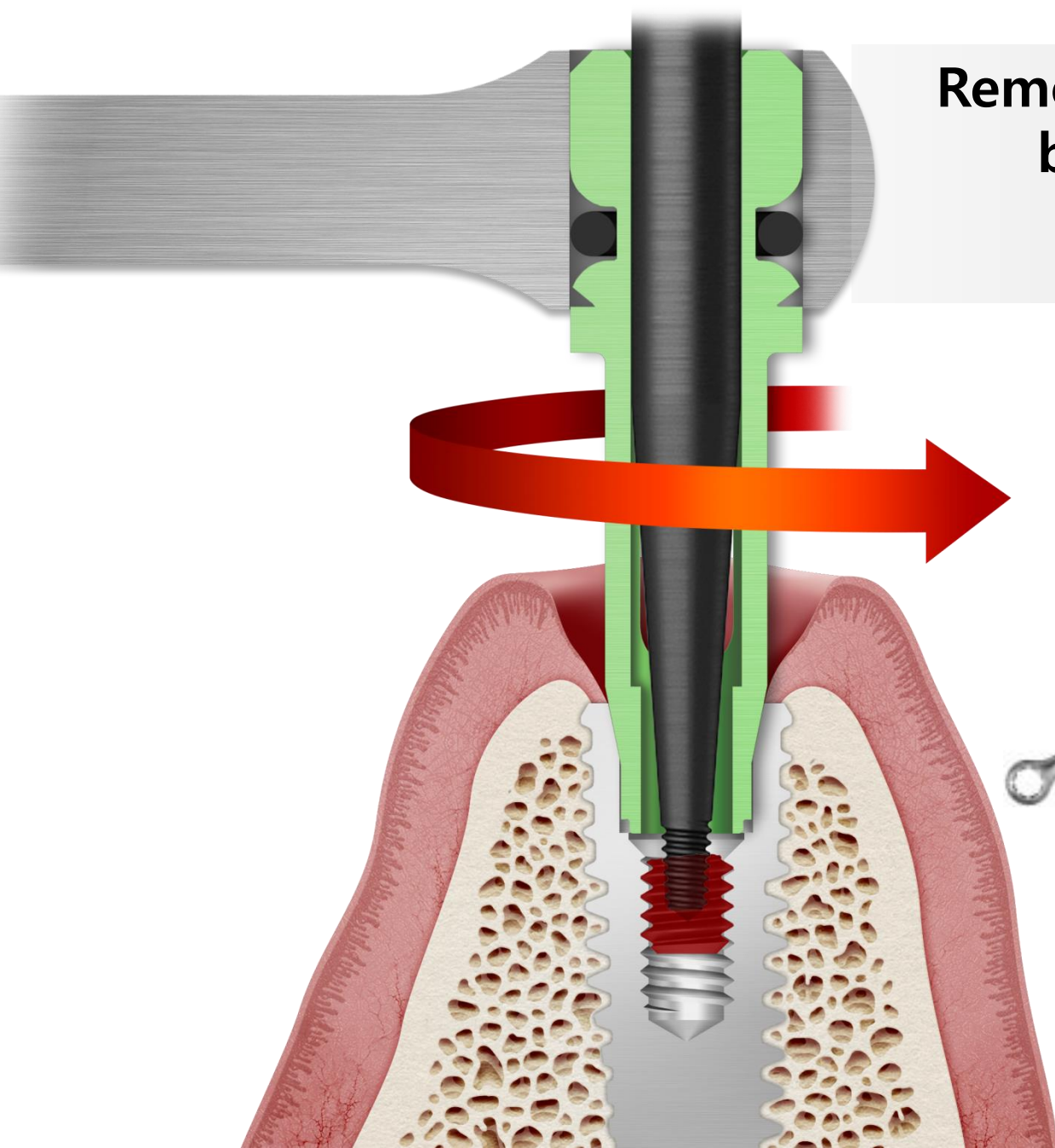

Removing fractured screw
by turning "SR Tip" to
counter-clockwise

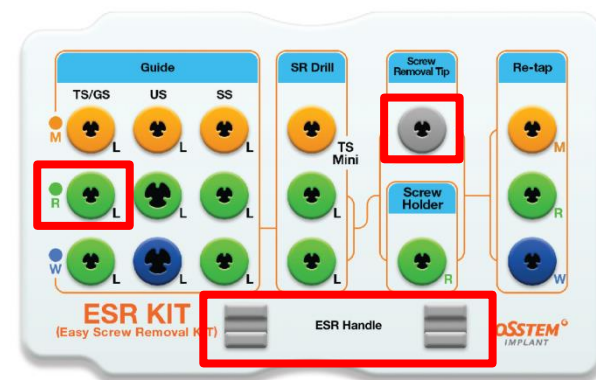
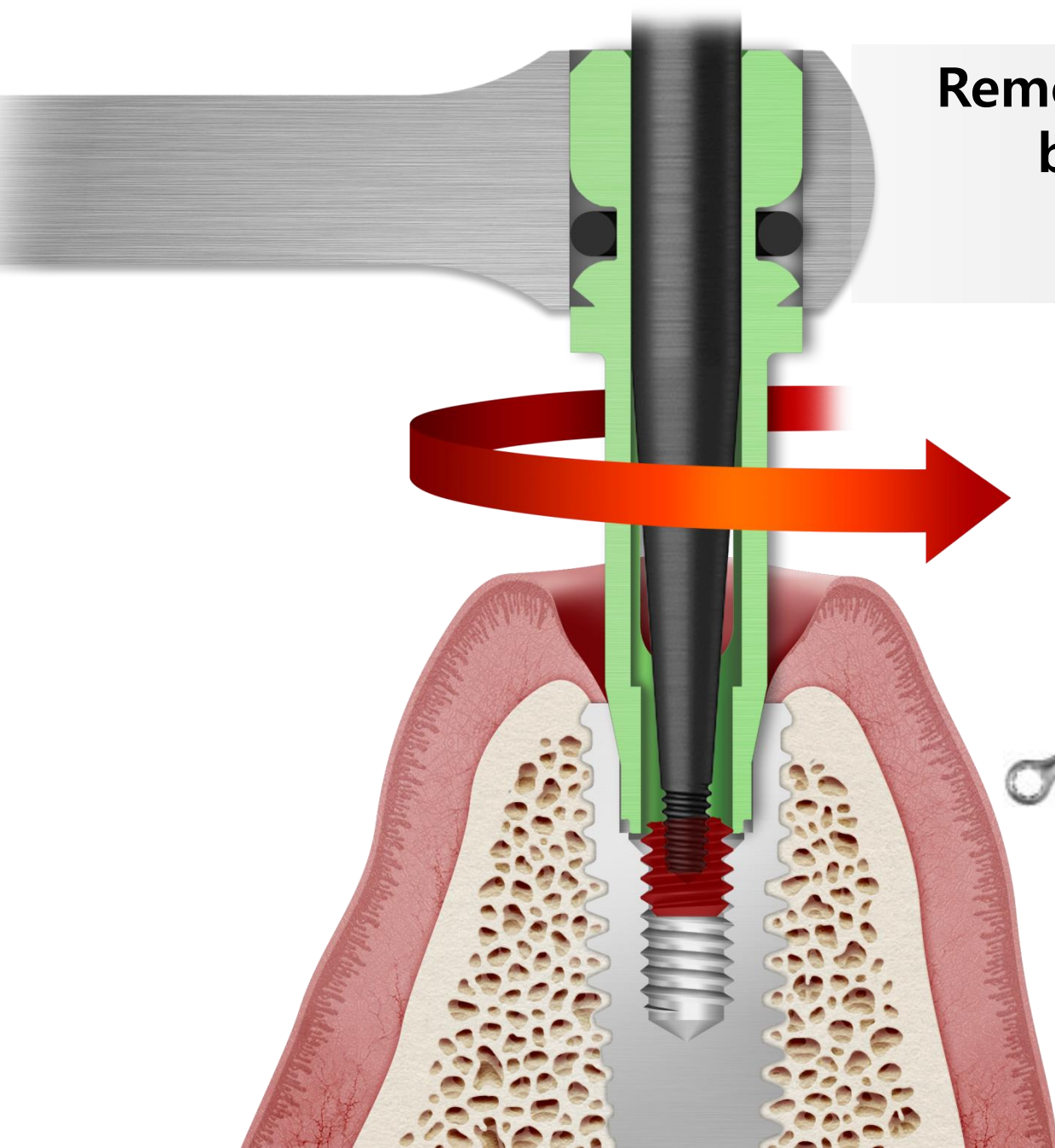

Removing fractured screw
by turning "SR Tip" to
counter-clockwise

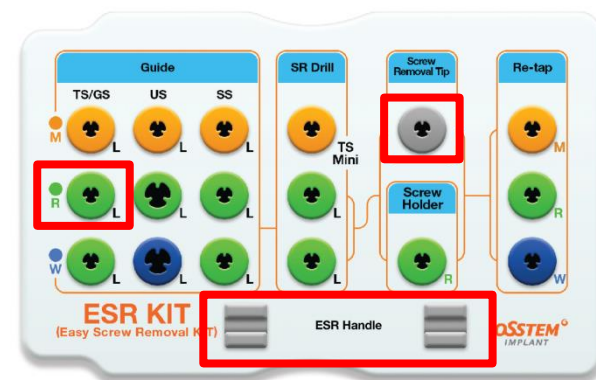
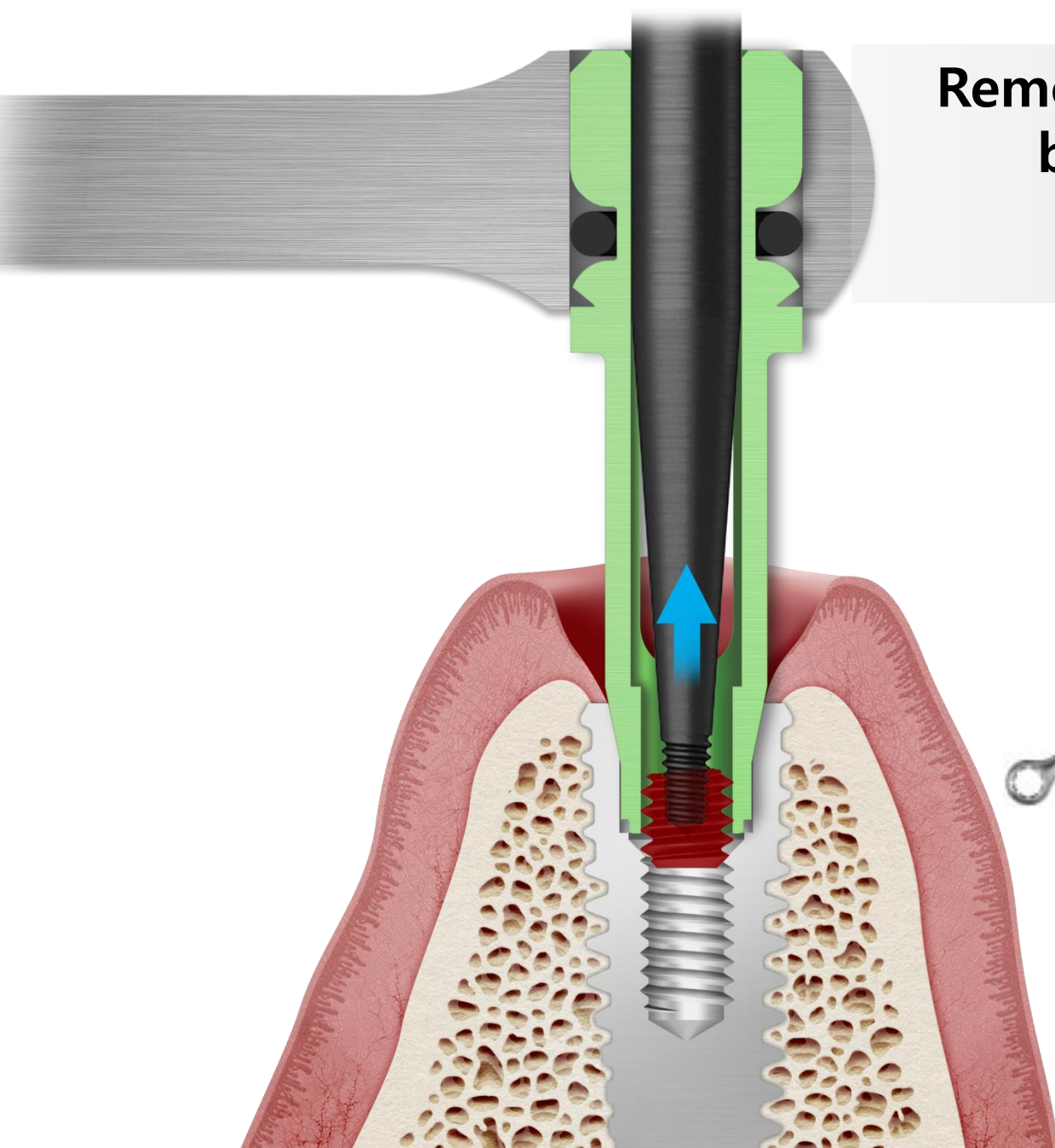

Removing fractured screw by turning "SR Tip" to counter-clockwise

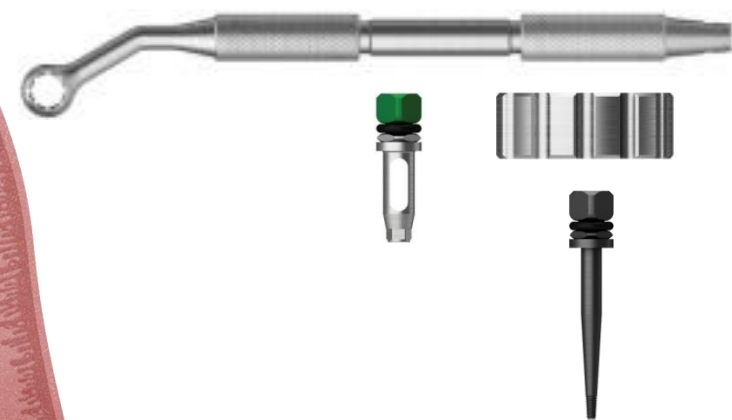
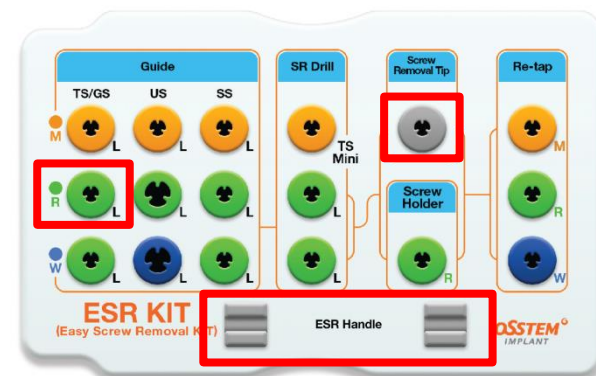
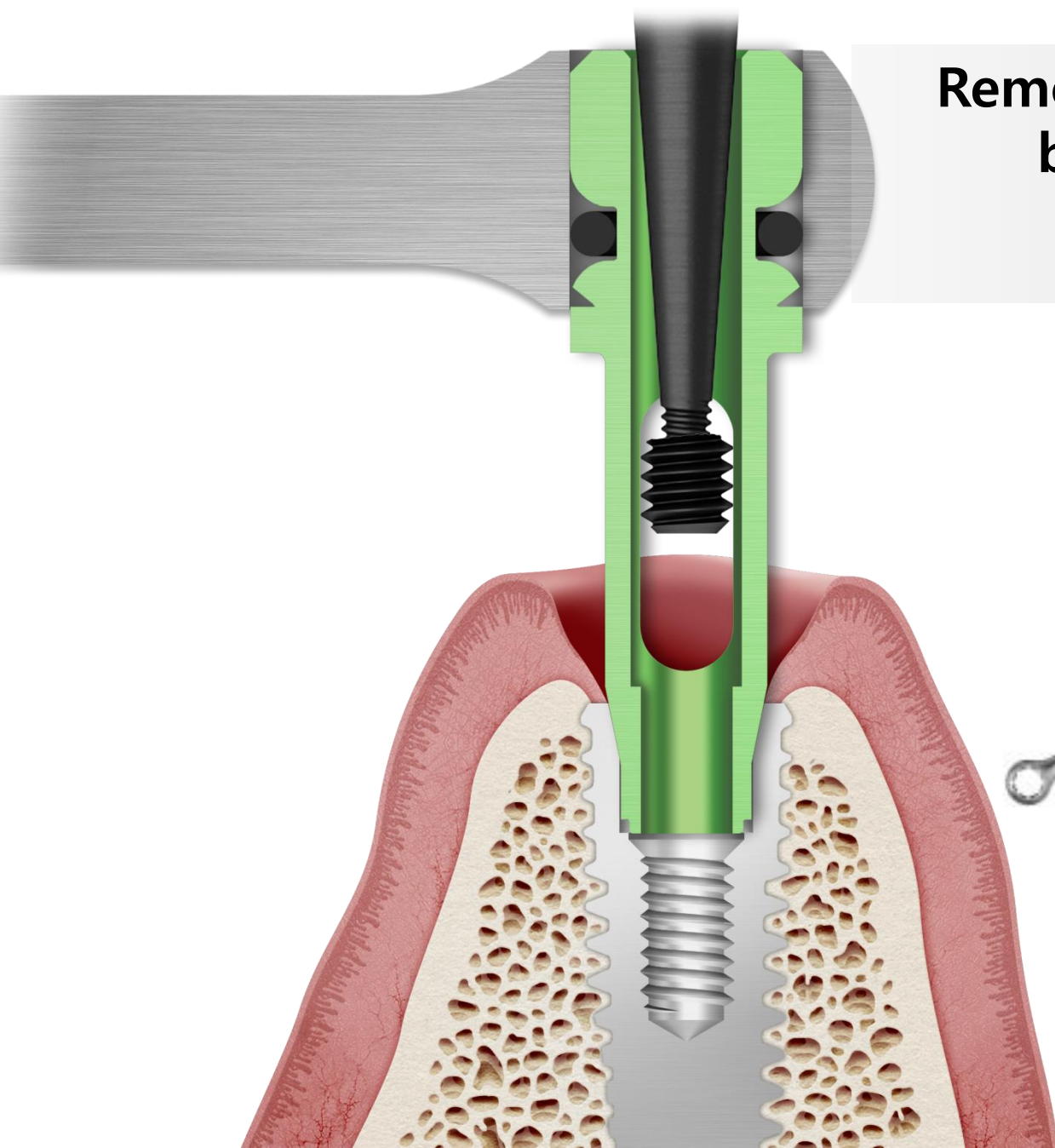

Removing fractured screw
by turning "SR Tip"
to counter-clockwise

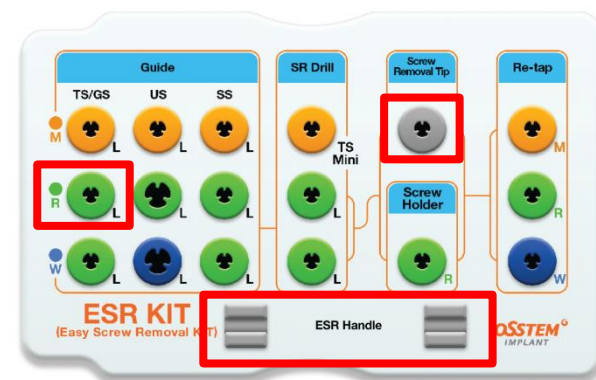
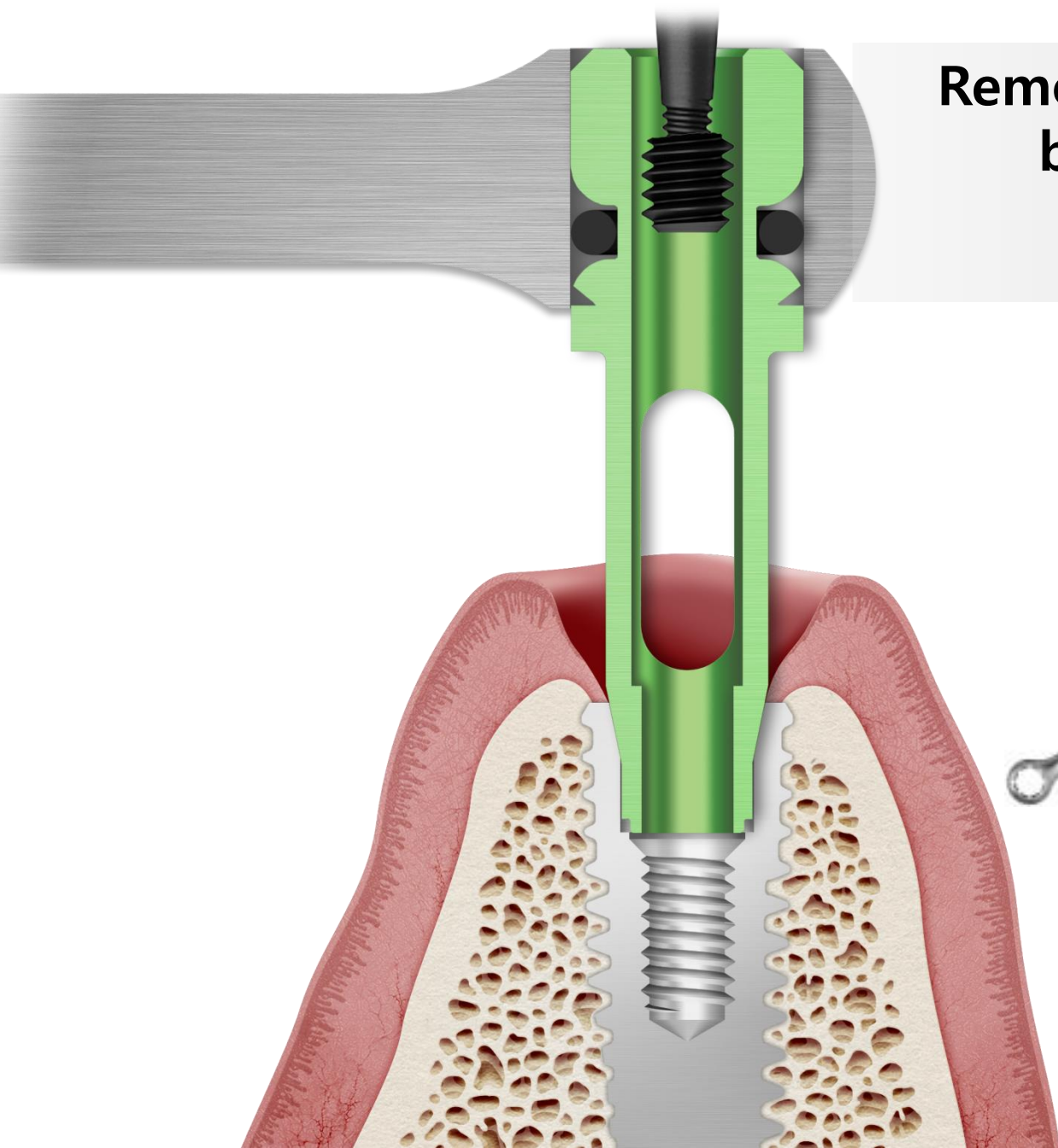

Separating "ESR Handle" and "Guide"

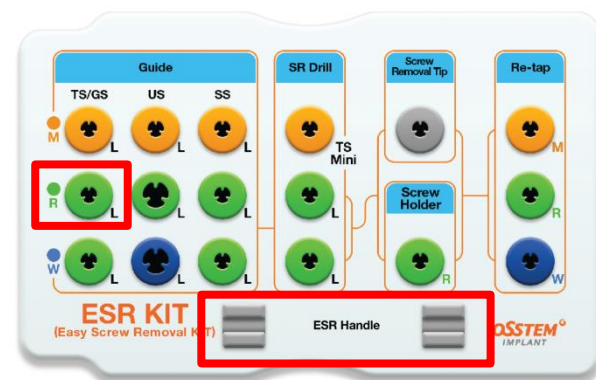
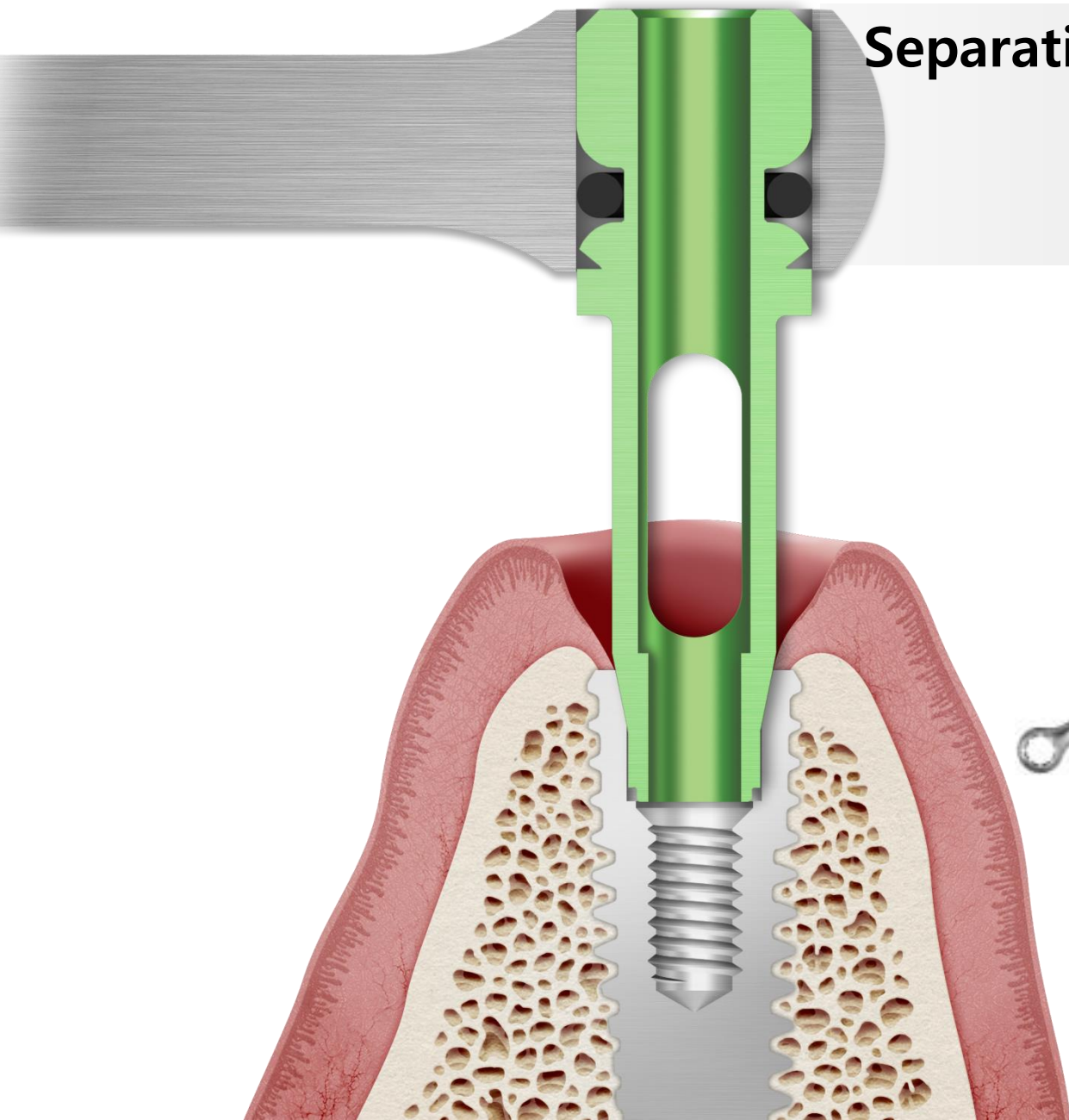

Fractured screw successfully removed

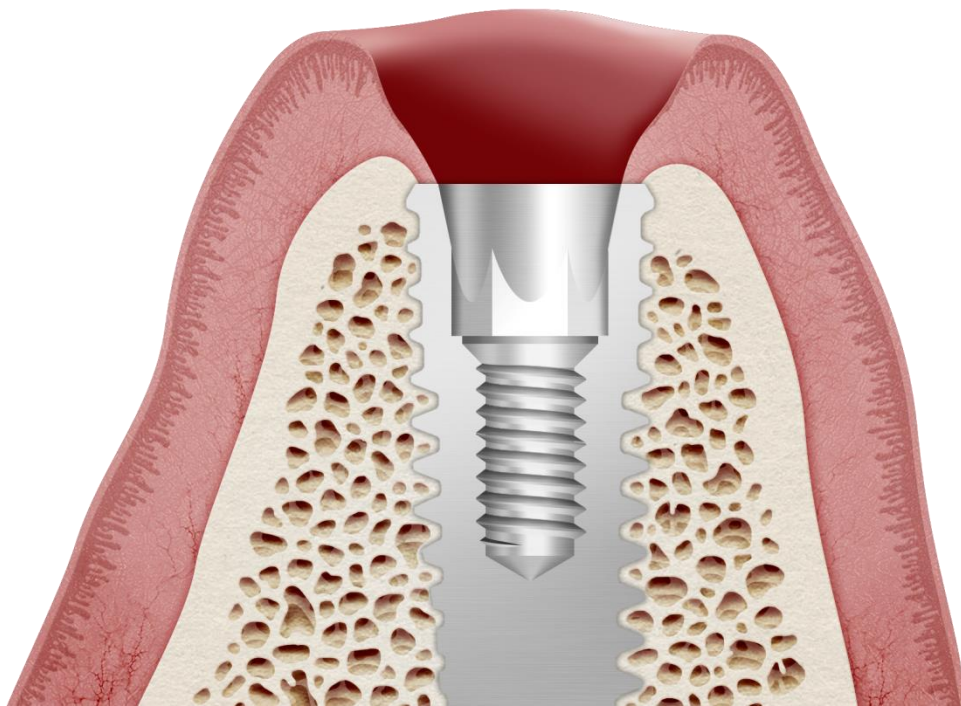

—

2. Fractured screw removal
using “Screw Holder”

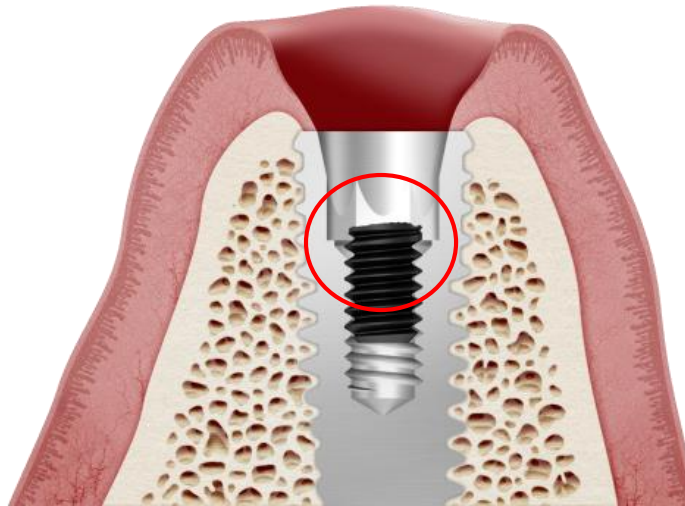

① For the case the fractured screw is protruded outside

Connecting "Torque driver Handle" to "Screw Holder"

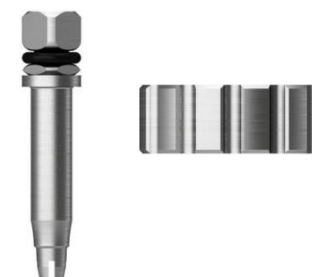
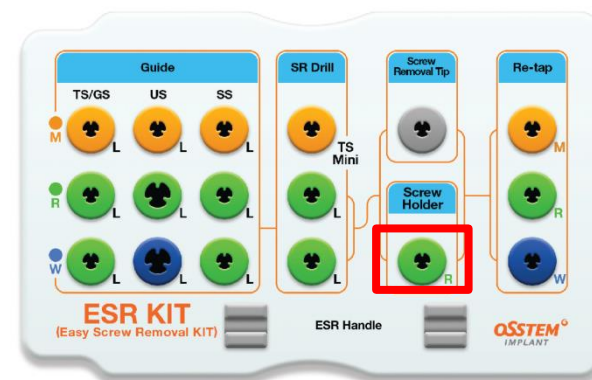
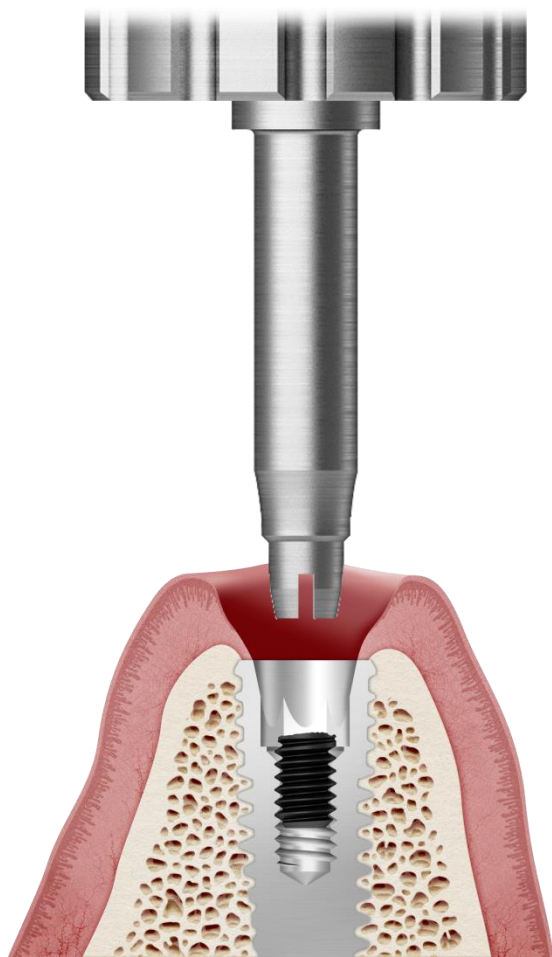

Putting "Screw Holder" inside the fixture

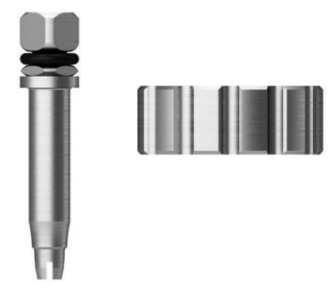
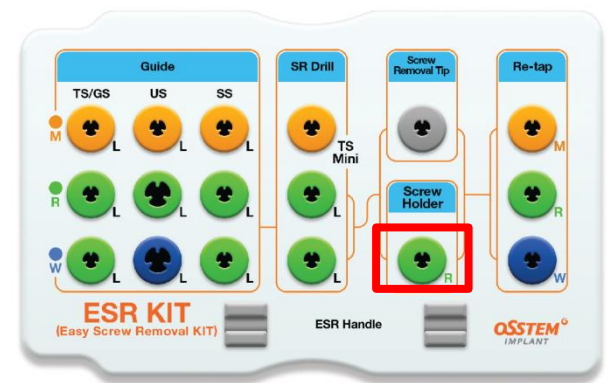
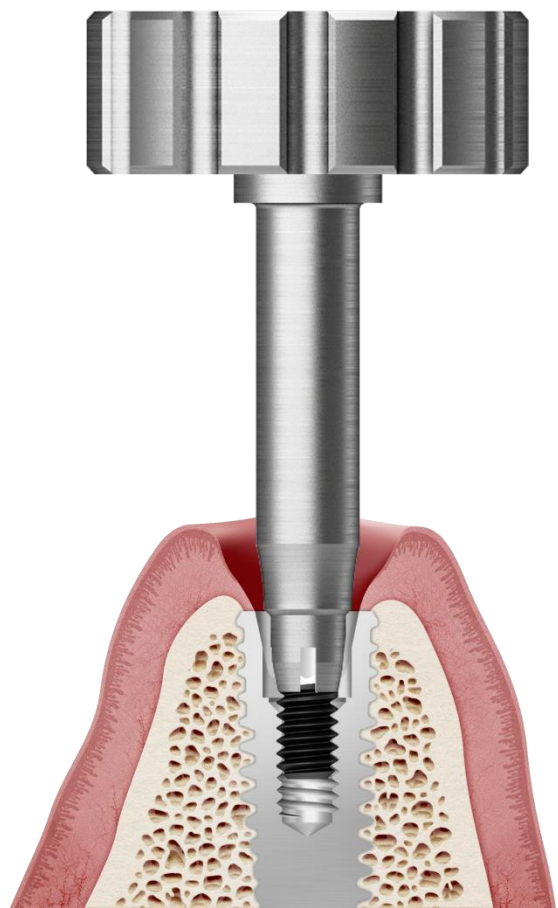

Removing fractured screw by turning "Screw Holder" counter-clockwise

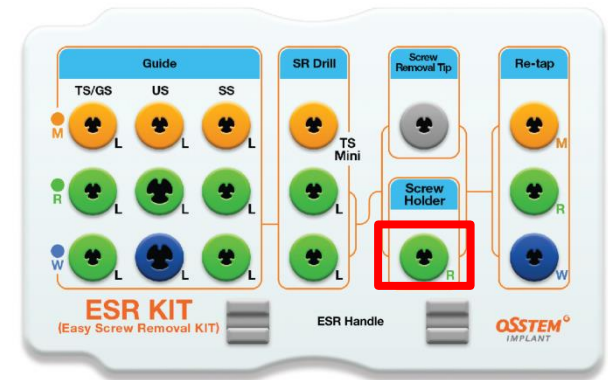
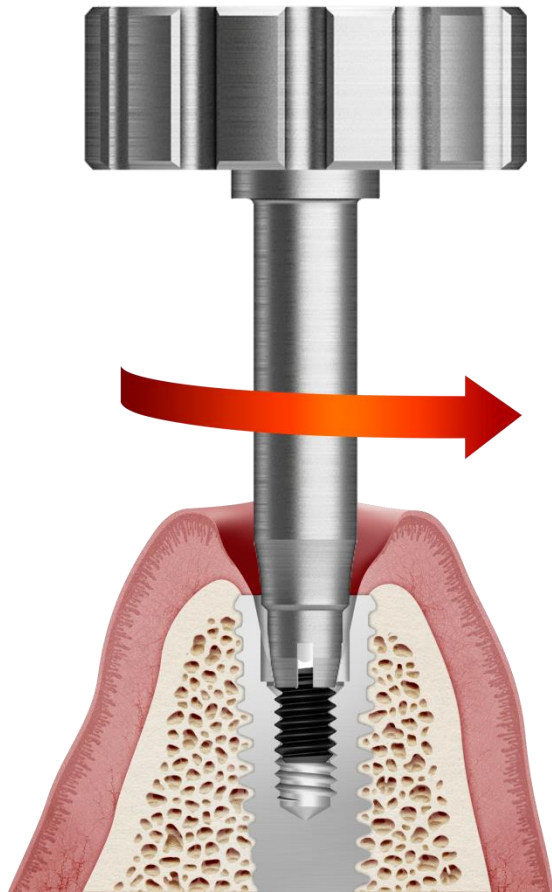

Removing fractured screw by turning "Screw Holder" counter-clockwise

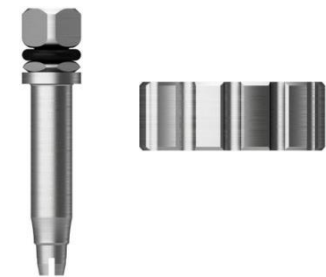
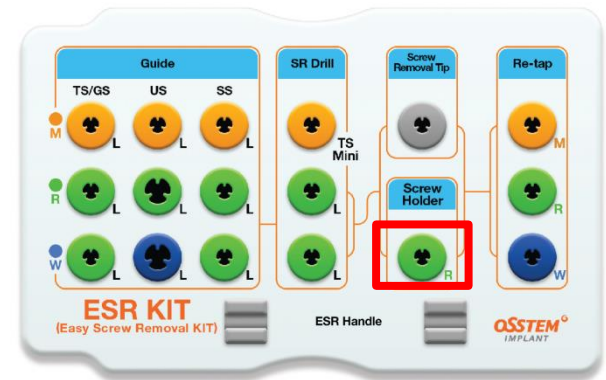
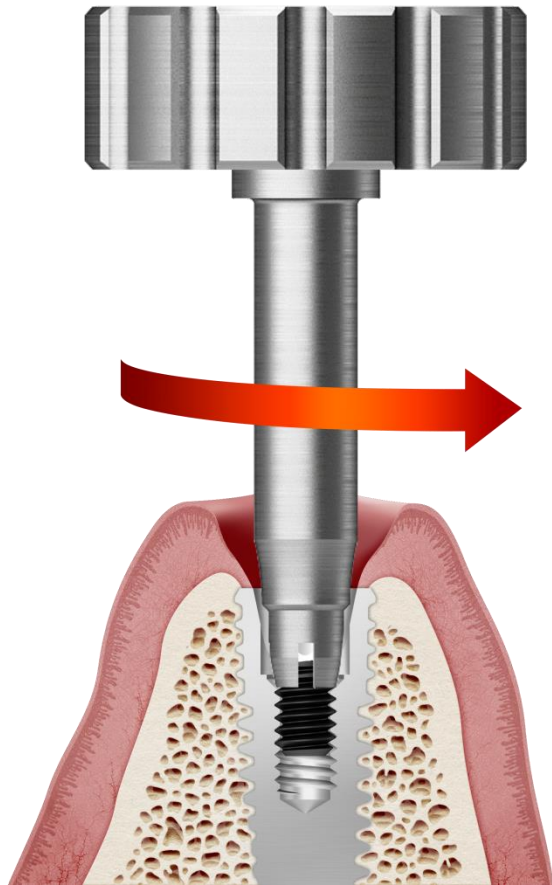

Removing fractured screw by turning "Screw Holder" counter-clockwise

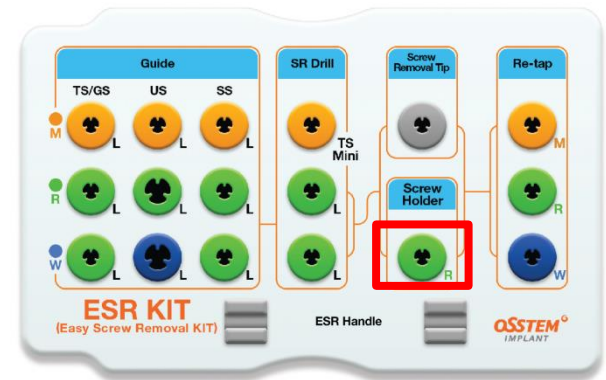
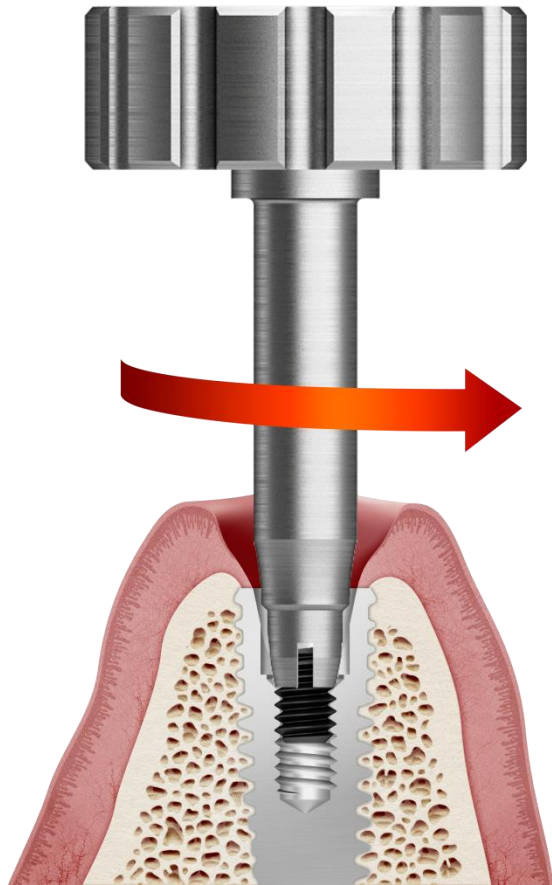

Removing fractured screw by turning "Screw Holder" counter-clockwise

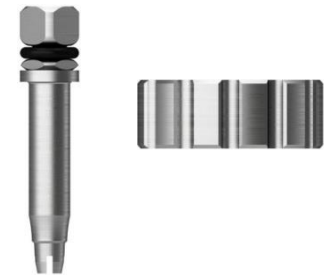
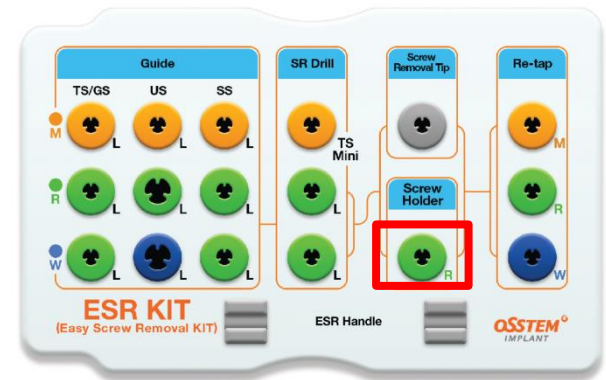
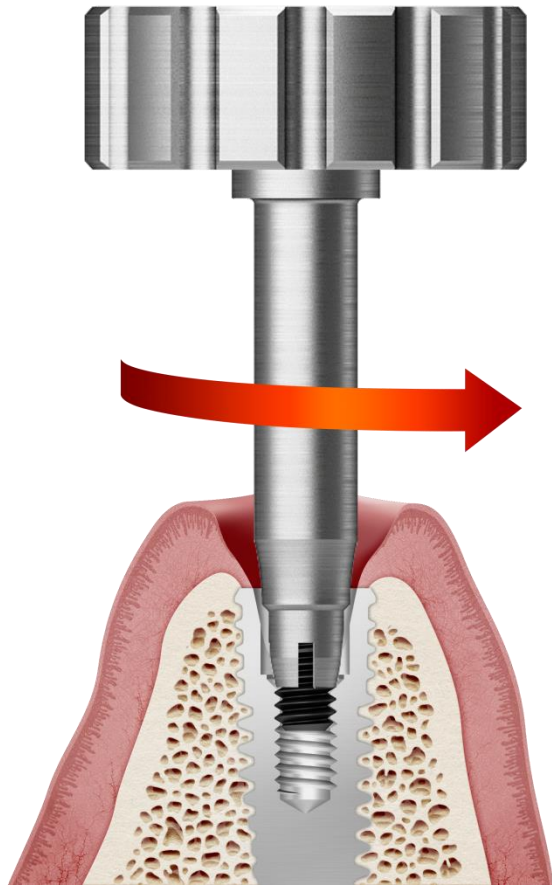

Removing fractured screw by turning "Screw Holder" counter-clockwise

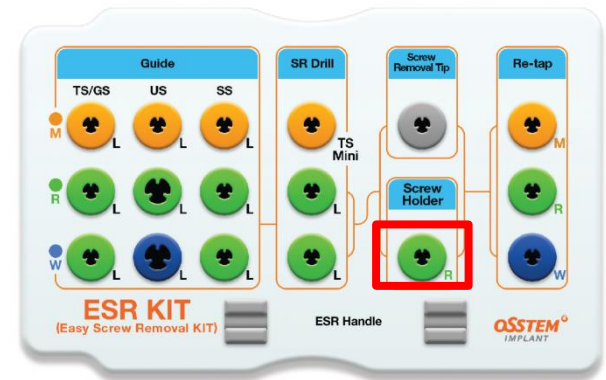
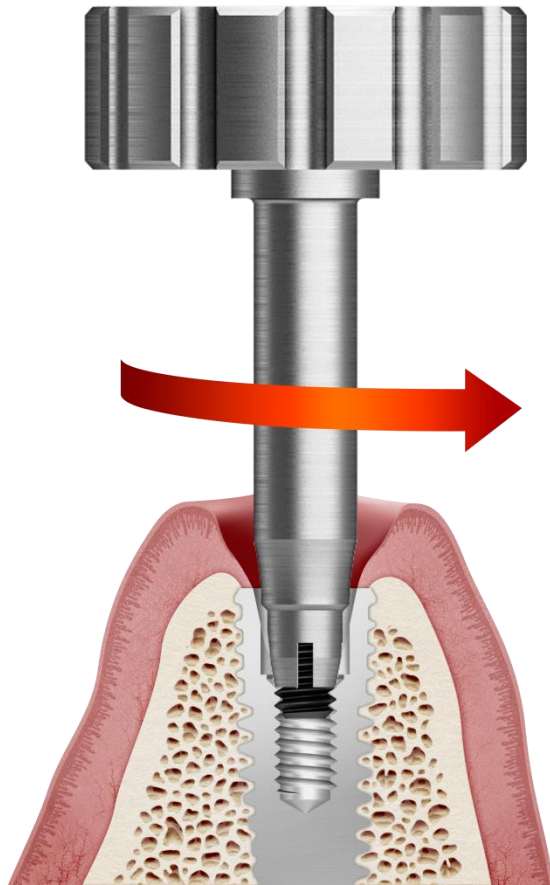

Removing fractured screw by turning "Screw Holder" counter-clockwise

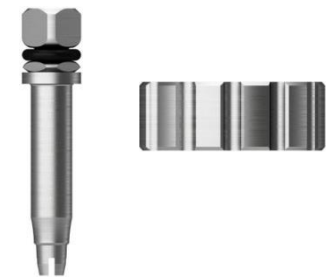
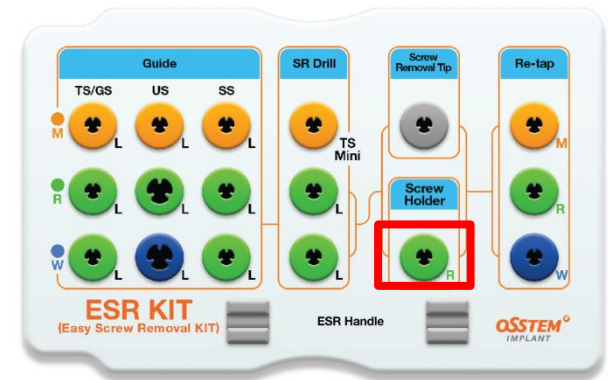
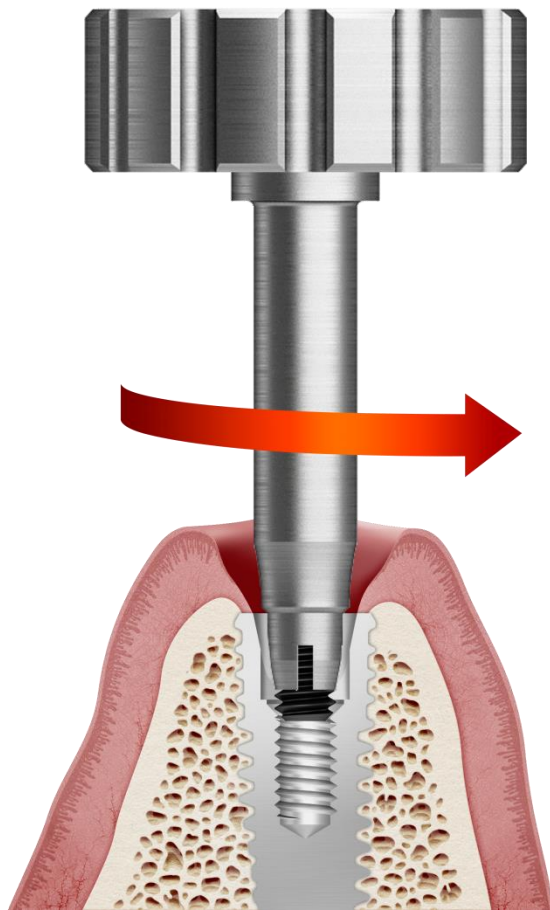

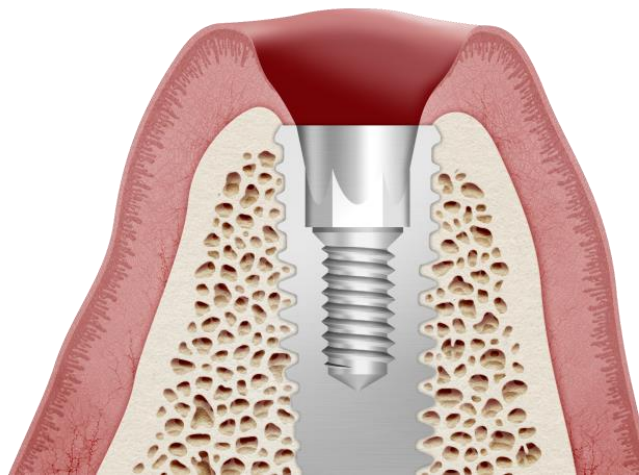

Screw successfully removed